

This drawing cannot be reproduced, copied or given to
third parties without FRIULAIR's written authorization

Questo disegno non può essere copiato, riprodotto né ceduto
a terzi senza autorizzazione scritta della FRIULAIR S.r.l.

Titolo - Title

SCHEMA ELETTRICO CWM008÷014
ELECTRICAL DIAGRAM CWM008÷014

Disegno n° - Drawing nr.

FRCWM90CWM014C0000

Revisione - Revision

00

FRIULAIR
Dryers

FRIULAIR S.r.l. - 33050 CERVIGNANO DEL FRIULI (UD) - ITALY - Via Cisis, 36

This drawing cannot be reproduced, copied or given to third parties without FRIULAIR's written authorization

Questo disegno non puo' essere copiato, riprodotto ne' ceduto a terzi senza autorizzazione scritta della FRIULAIR S.r.l.

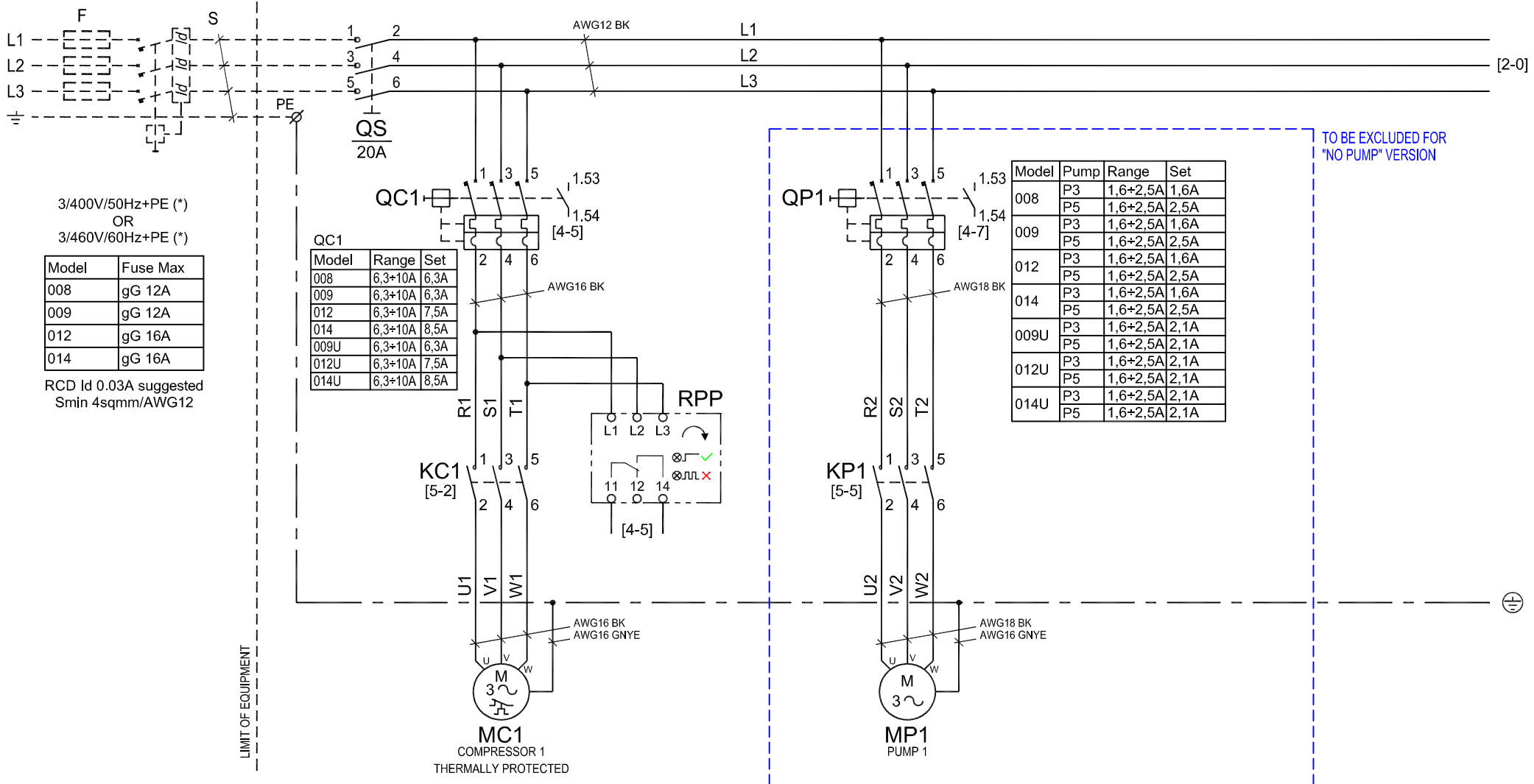

(*) See chiller nameplate

Technical modifications are subject to change without notice; errors not excluded



Titolo / Title :

SCHEMA ELETTRICO CWM008÷014 ELECTRICAL DIAGRAM CWM008÷014

FRIULAIR S.r.l. - 33050 CERVIGNANO DEL FRIULI (UD) - ITALY - Via Cisis, 36

Drawing no. :

FRCWM90CWM014C0000

Rev.

00

Note :

-

Sheet 1 of 9

COMPUTER AIDED DESIGN

This drawing cannot be reproduced, copied or given to third parties without FRIULAIR's written authorization

Questo disegno non può essere copiato, riprodotto né ceduto a terzi senza autorizzazione scritta della FRIULAIR S.r.l.

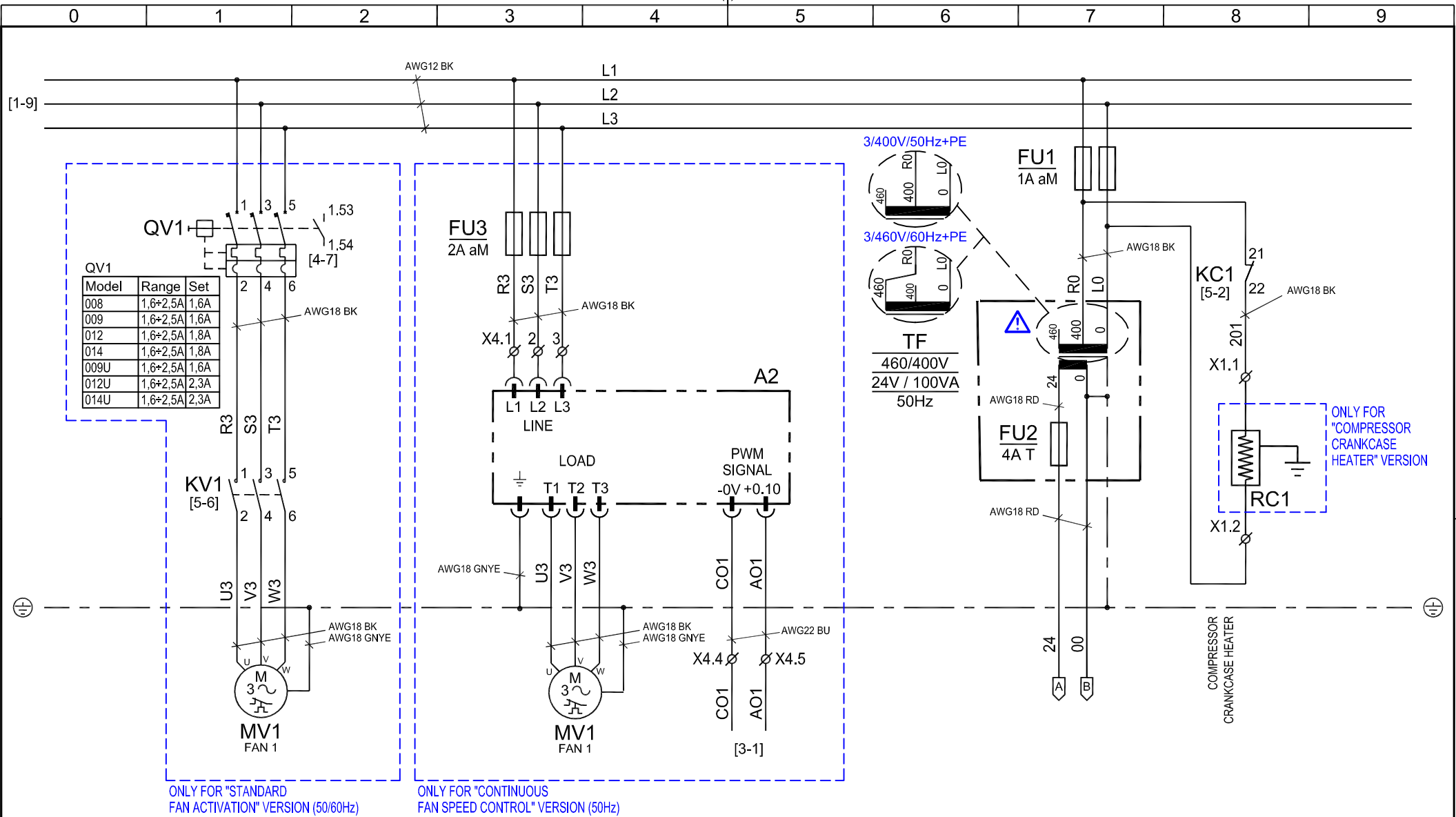

Technical modifications are subject to change without notice; errors not excluded

	Titolo / Title :	SCHEMA ELETTRICO CWM008÷014 ELECTRICAL DIAGRAM CWM008÷014	Drawing no. :	FRCWM90CWM014C0000 00
	FRIULAIR S.r.l. - 33050 CERVIGNANO DEL FRIULI (UD) - ITALY - Via Cisis, 36			Note :

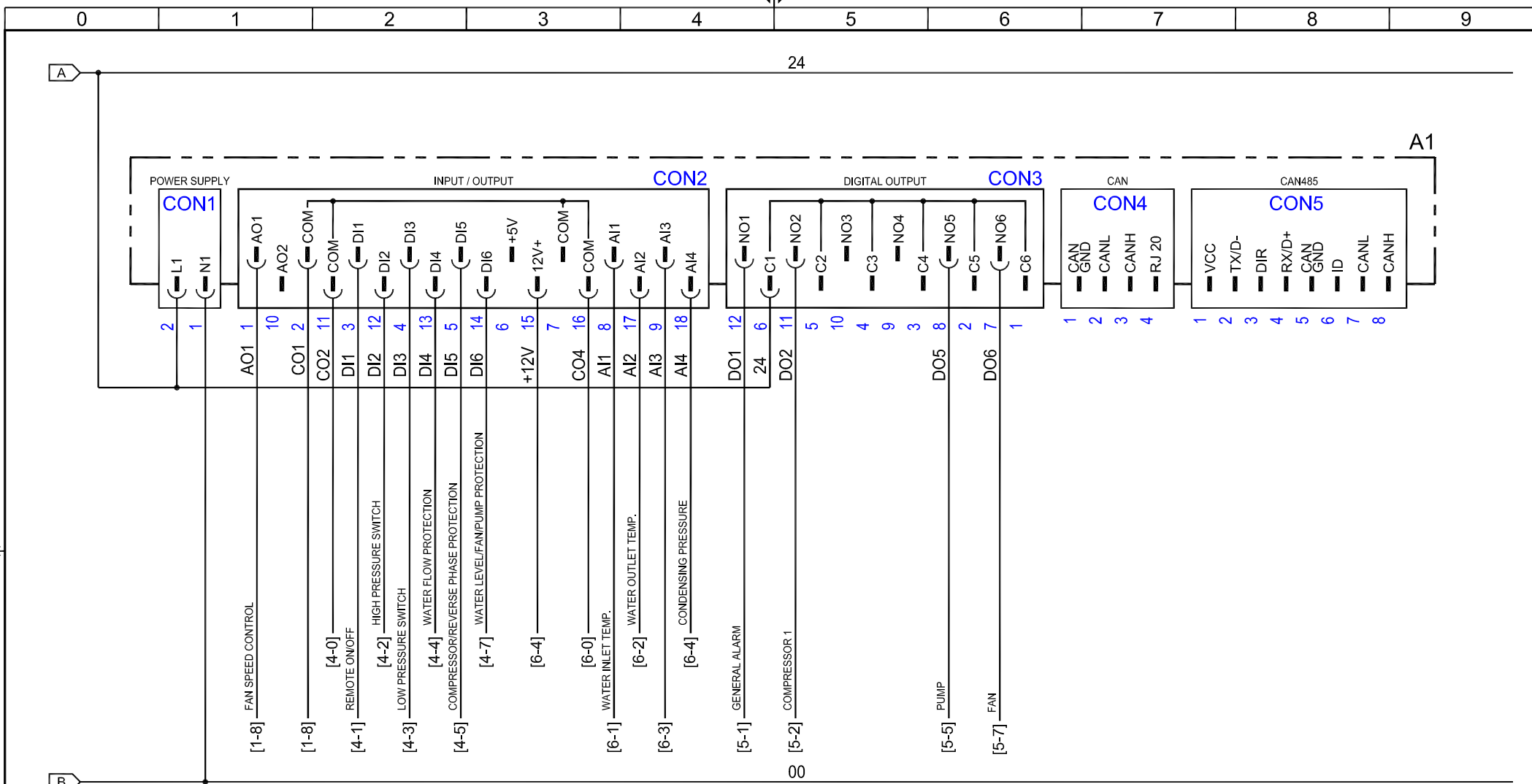

Technical modifications are subject to change without notice; errors not excluded



Titolo / Title :

SCHEMA ELETTRICO CWM008÷014 ELECTRICAL DIAGRAM CWM008÷014

FRIULAIR S.r.l. - 33050 CERVIGNANO DEL FRIULI (UD) - ITALY - Via Cisis, 36

Drawing no. : FRCWM90CWM014C0000

Rev. 00

Note :

-

Sheet 3 of 9

COMPUTER AIDED DESIGN

This drawing cannot be reproduced, copied or given to third parties without FRIULAIR's written authorization

Questo disegno non può essere copiato, riprodotto né ceduto a terzi senza autorizzazione scritta della FRIULAIR S.r.l.

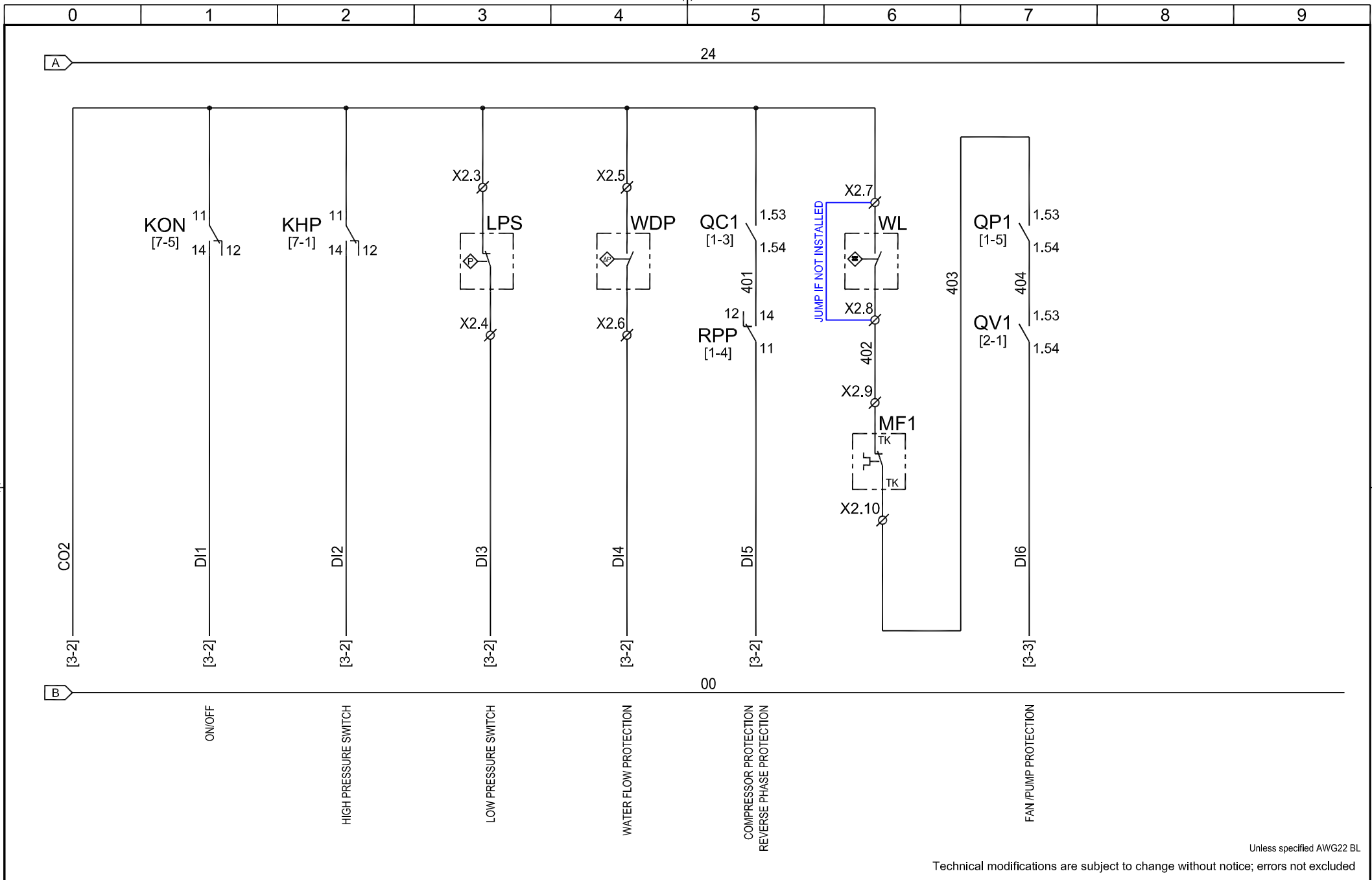

Unless specified AWG22 BL
 Technical modifications are subject to change without notice; errors not excluded



Titolo / Title :

SCHEMA ELETTRICO CWM008÷014
ELECTRICAL DIAGRAM CWM008÷014

FRIULAIR S.r.l. - 33050 CERVIGNANO DEL FRIULI (UD) - ITALY - Via Cisis, 36

Drawing no. :

FRCWM90CWM014C0000

Rev.

00

Note :

-

Sheet **4** of **9**

COMPUTER AIDED DESIGN

This drawing cannot be reproduced, copied or given to third parties without FRIULAIR's written authorization

Questo disegno non può essere copiato, riprodotto né ceduto a terzi senza autorizzazione scritta della FRIULAIR S.r.l.

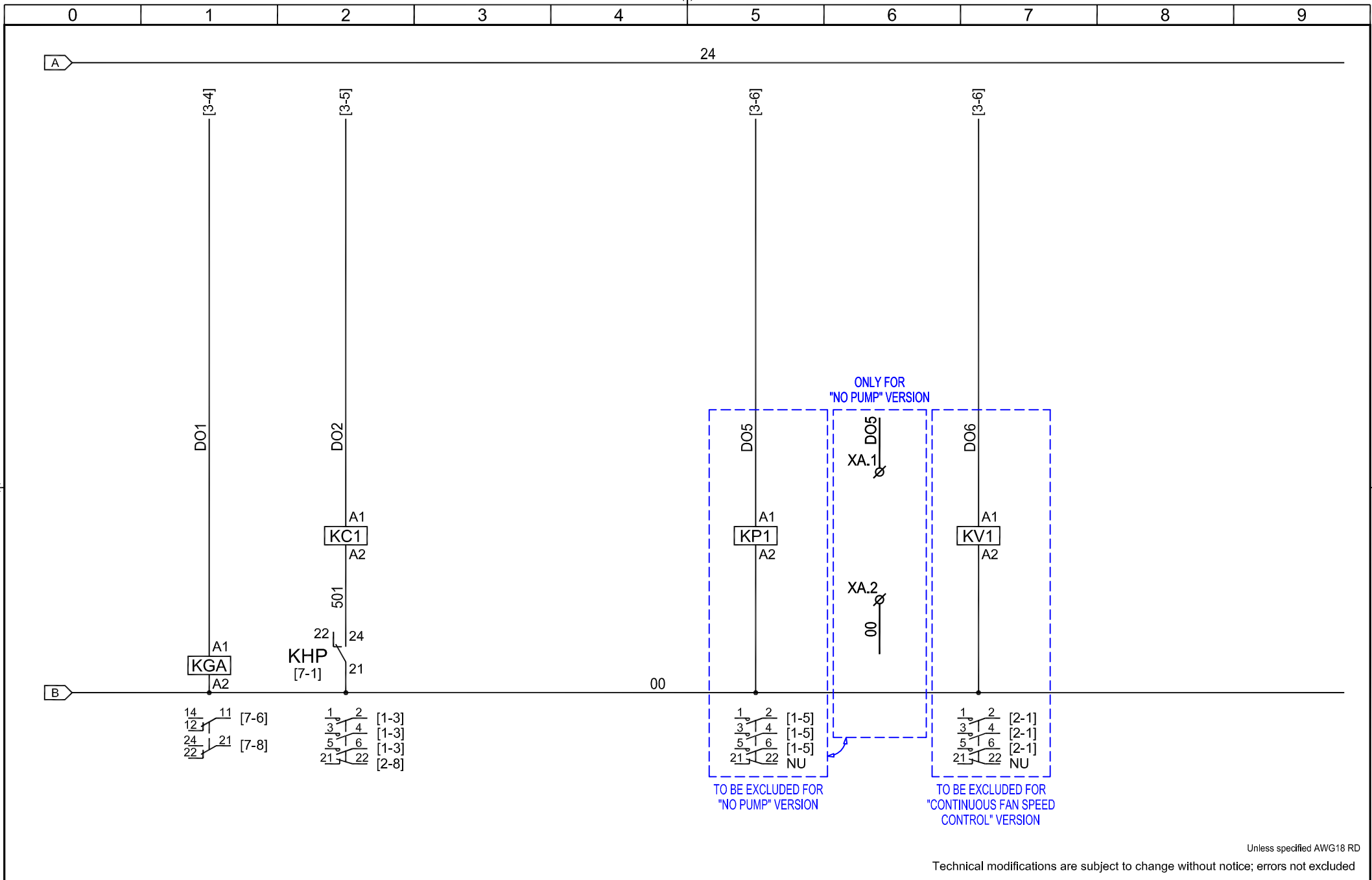

Unless specified AWG18 RD
 Technical modifications are subject to change without notice; errors not excluded

	Titolo / Title : SCHEMA ELETTRICO CWM008÷014 ELECTRICAL DIAGRAM CWM008÷014	Drawing no. : FRCWM90CWM014C0000	Rev. 00
	FRIULAIR S.r.l. - 33050 CERVIGNANO DEL FRIULI (UD) - ITALY - Via Cisis, 36	Note : -	Sheet 5 of 9

This drawing cannot be reproduced, copied or given to third parties without FRIULAIR's written authorization

Questo disegno non può essere copiato, riprodotto né ceduto a terzi senza autorizzazione scritta della FRIULAIR S.r.l.

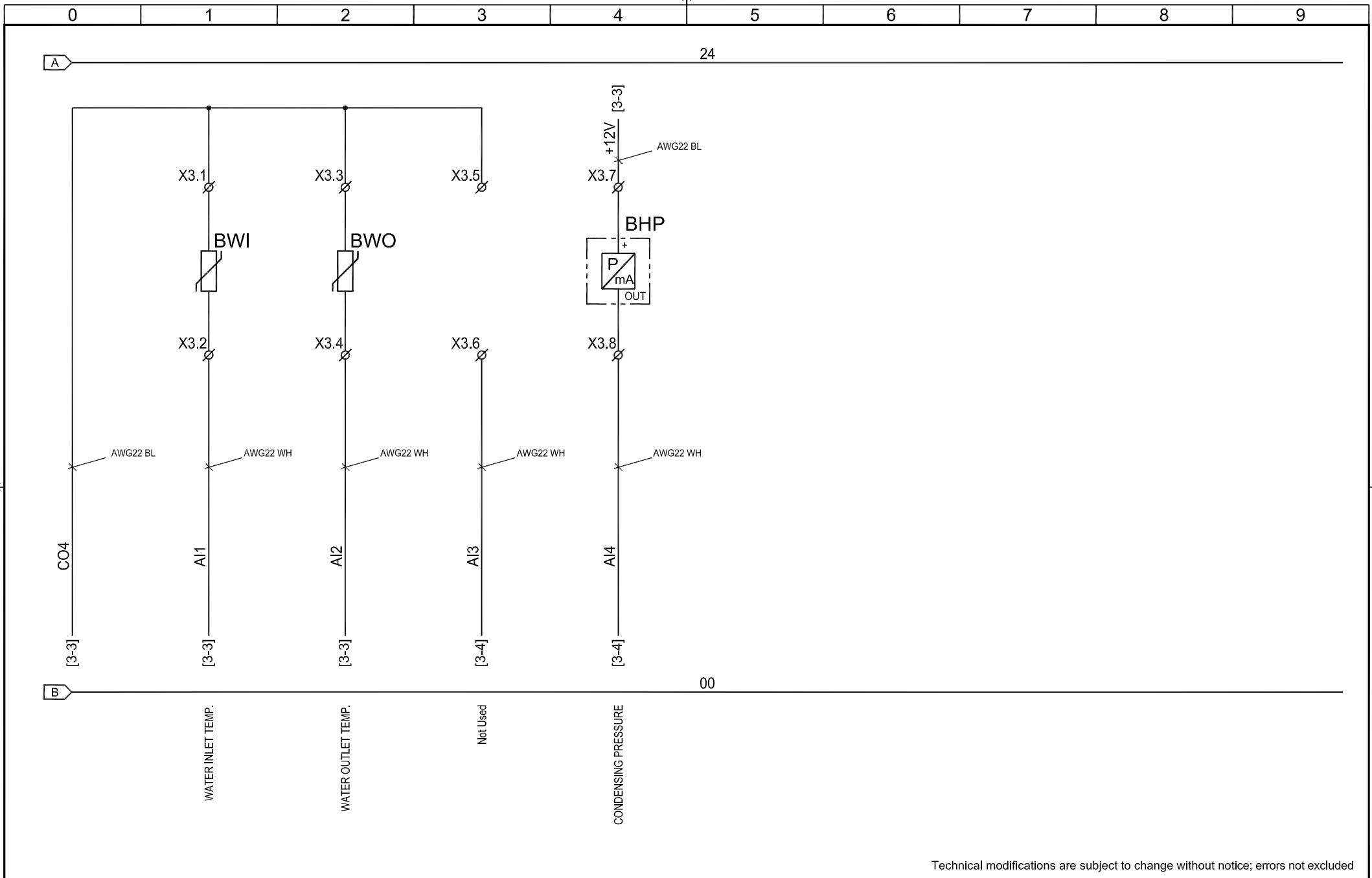

Technical modifications are subject to change without notice; errors not excluded



Titolo / Title :

SCHEMA ELETTRICO CWM008÷014 ELECTRICAL DIAGRAM CWM008÷014

FRIULAIR S.r.l. - 33050 CERVIGNANO DEL FRIULI (UD) - ITALY - Via Cisis, 36

Drawing no. :

FRCWM90CWM014C0000

Rev.

00

Note :

-

Sheet 6 of 9

COMPUTER AIDED DESIGN

This drawing cannot be reproduced, copied or given to third parties without FRIULAIR's written authorization

Questo disegno non puo' essere copiato, riprodotto ne' ceduto a terzi senza autorizzazione scritta della FRIULAIR S.r.l.

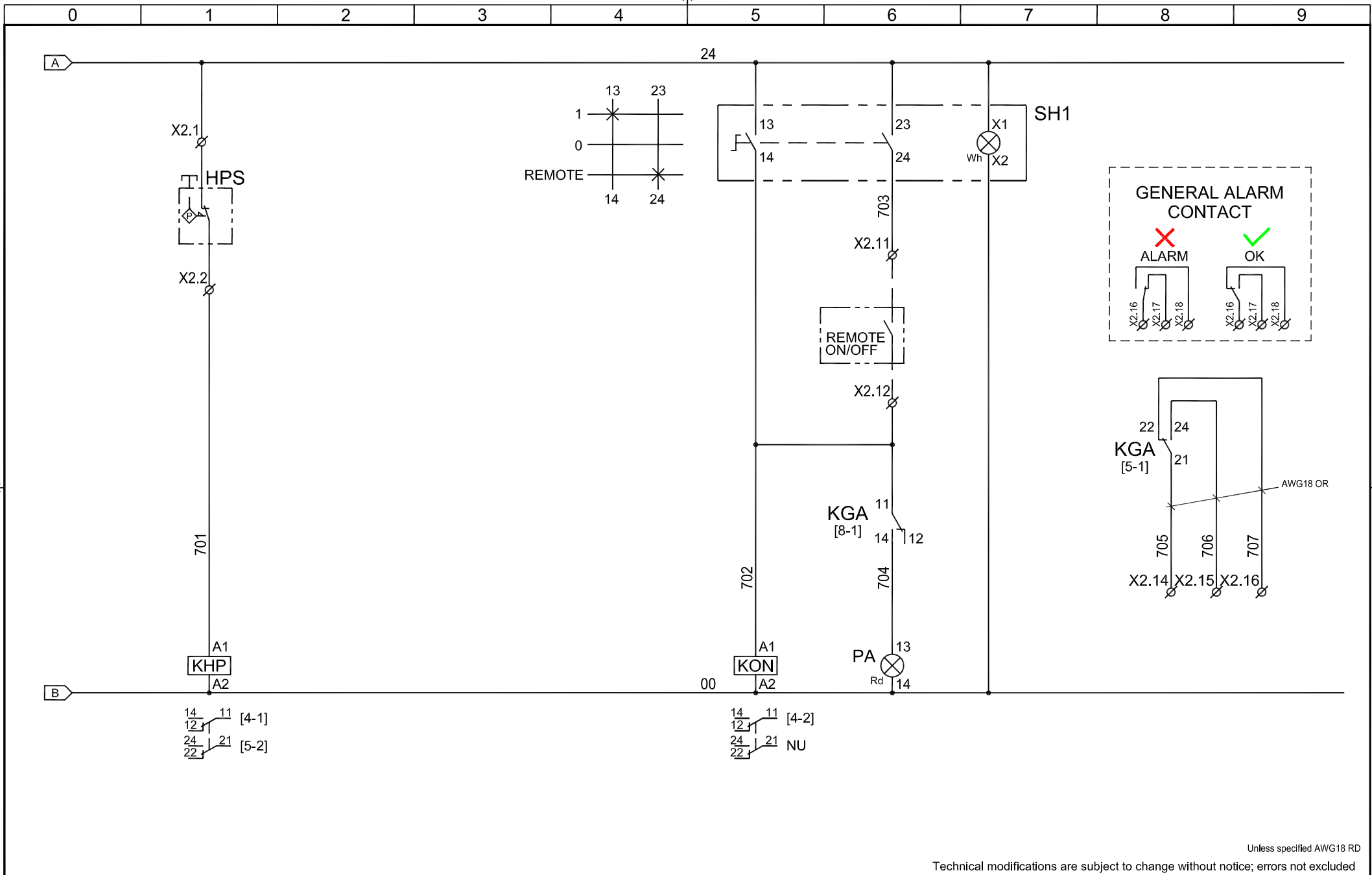

Titolo / Title :

SCHEMA ELETTRICO CWM008÷014

ELECTRICAL DIAGRAM CWM008÷014

FRIULAIR S.r.l. - 33050 CERVIGNANO DEL FRIULI (UD) - ITALY - Via Cisis, 36

Drawing no. :

FRCWM90CWM014C0000

Rev.

00

Note :

-

Sheet 7 of 9

COMPUTER AIDED DESIGN

This drawing cannot be reproduced, copied or given to third parties without FRIULAIR's written authorization

Questo disegno non può essere copiato, riprodotto né ceduto a terzi senza autorizzazione scritta della FRIULAIR S.r.l.

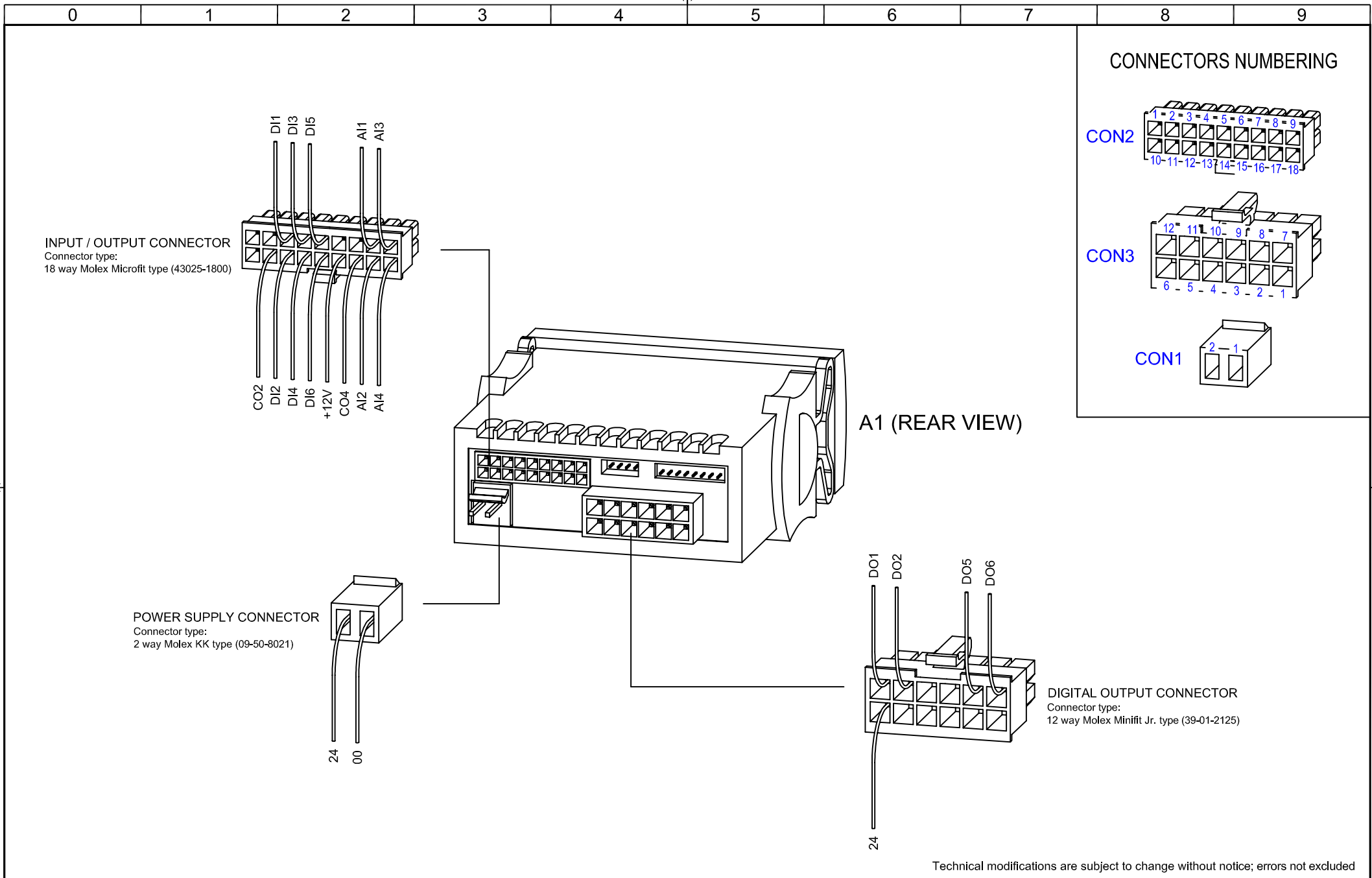

Technical modifications are subject to change without notice; errors not excluded



Titolo / Title : **SCHEMA ELETTRICO CWM008÷014**
ELECTRICAL DIAGRAM CWM008÷014
 FRIULAIR S.r.l. - 33050 CERVIGNANO DEL FRIULI (UD) - ITALY - Via Cisis, 36

Drawing no. : **FRCWM90CWM014C0000** Rev. **00**
 Note :
 - Sheet **9** of **9**