

This drawing cannot be reproduced, copied or given to
third parties without FRIULAIR's written authorization

Questo disegno non può essere copiato, riprodotto né ceduto
a terzi senza autorizzazione scritta della FRIULAIR S.r.l.

Titolo - Title

SCHEMA ELETTRICO CWU010÷020
ELECTRICAL DIAGRAM CWU010÷020

Disegno n° - Drawing nr.

FRCWU90CWU020Q0000

Revisione - Revision

00

FRIULAIR
Dryers

FRIULAIR S.r.l. - 33050 CERVIGNANO DEL FRIULI (UD) - ITALY - Via Cisis, 36

This drawing cannot be reproduced, copied or given to third parties without FRIULAIR's written authorization

Questo disegno non puo' essere copiato, riprodotto ne' ceduto a terzi senza autorizzazione scritta della FRIULAIR S.r.l.

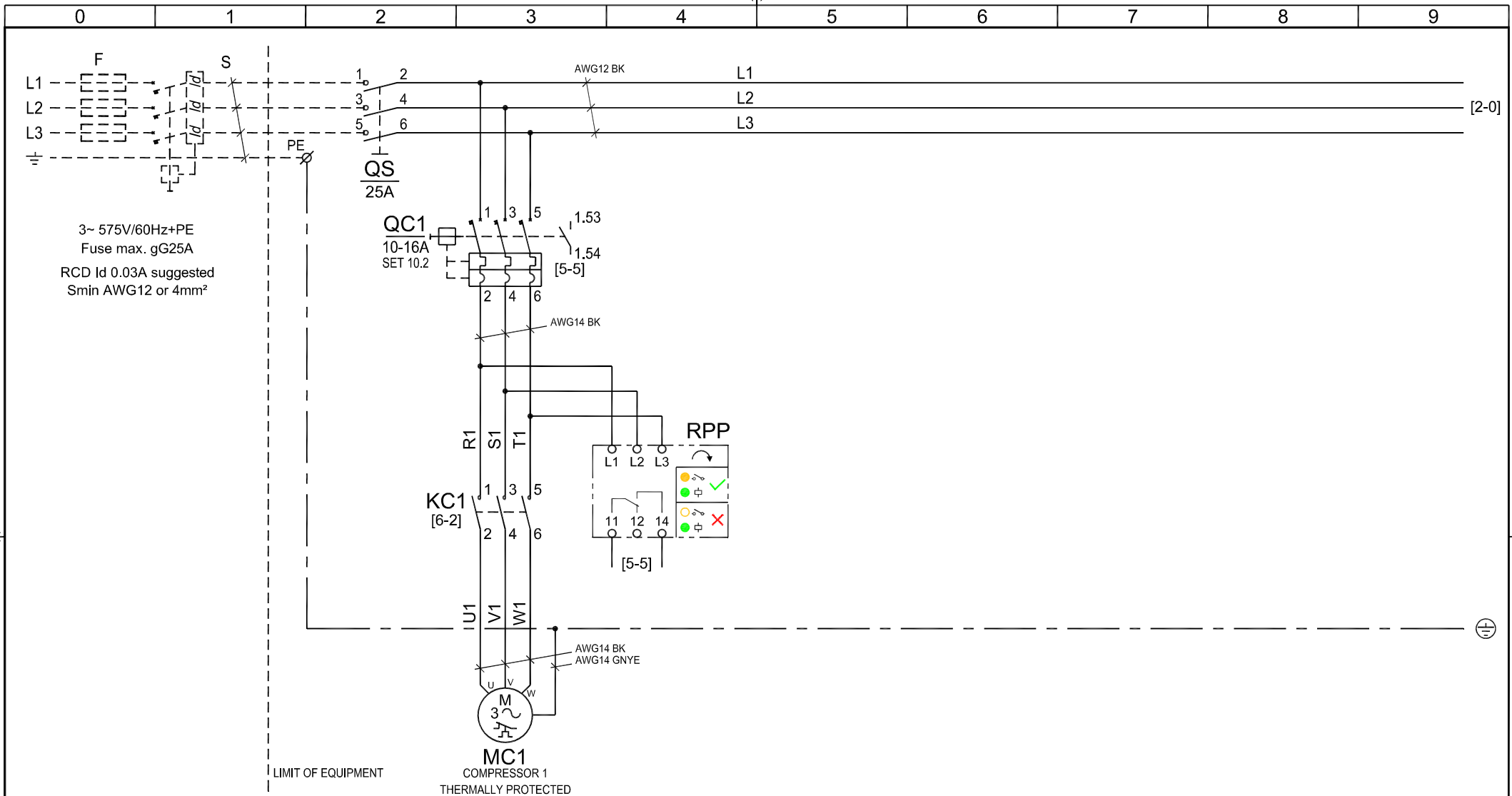

Technical modifications are subject to change without notice; errors not excluded

FRIULAIR
Dryers

Titolo / Title :

SCHEMA ELETTRICO CWU020
ELECTRICAL DIAGRAM CWU020

FRIULAIR S.r.l. - 33050 CERVIGNANO DEL FRIULI (UD) - ITALY - Via Cisis, 36

Drawing no. :
FQCWU90CWU020Q0000

Rev.
00

Note :

-

Sheet 1 of 10

COMPUTER AIDED DESIGN

This drawing cannot be reproduced, copied or given to third parties without FRIULAIR's written authorization

Questo disegno non può essere copiato, riprodotto né ceduto a terzi senza autorizzazione scritta della FRIULAIR S.r.l.

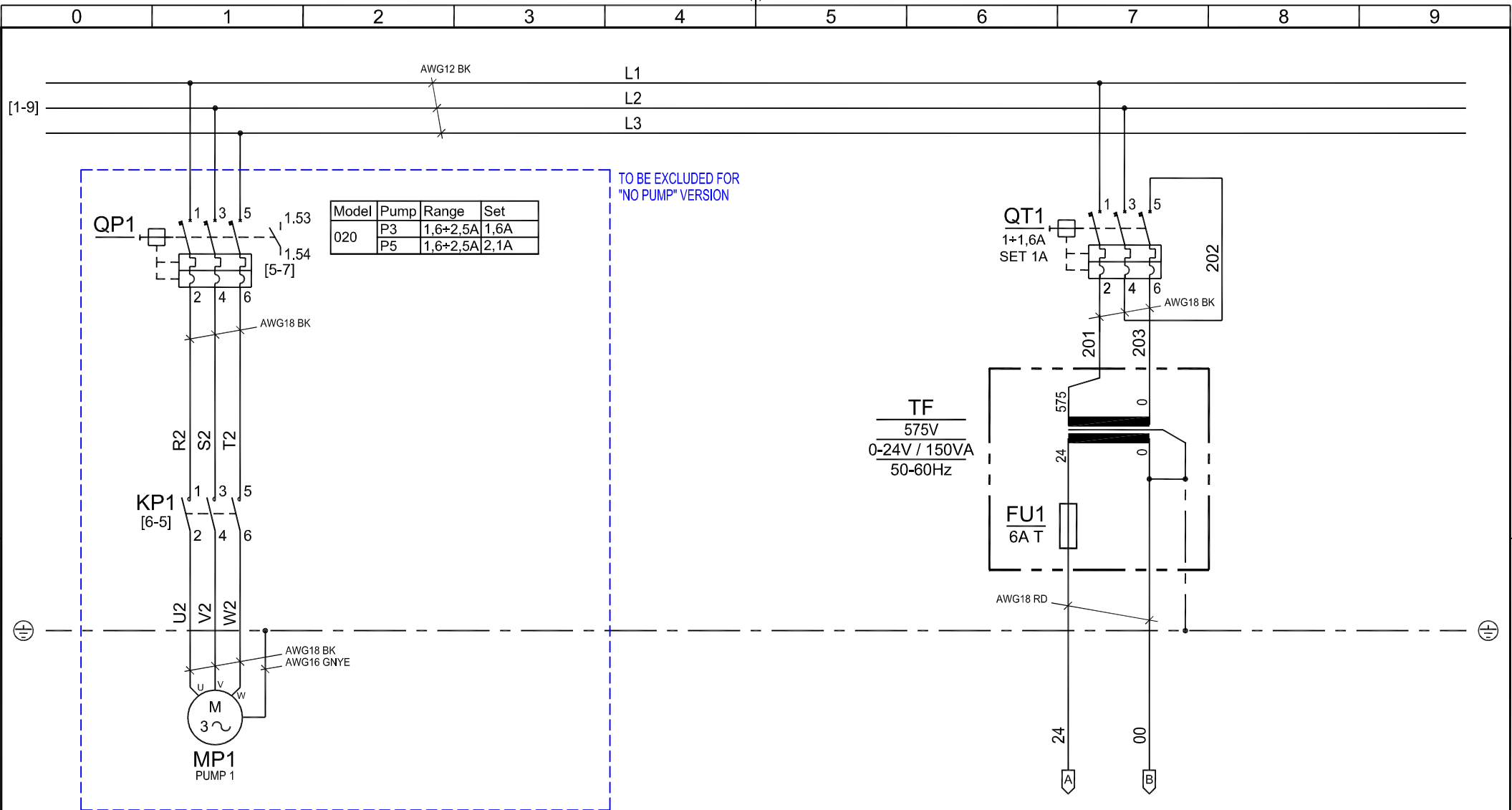

Model	Pump	Range	Set
020	P3	1,6+2,5A	1,6A
	P5	1,6+2,5A	2,1A

TO BE EXCLUDED FOR "NO PUMP" VERSION

Technical modifications are subject to change without notice; errors not excluded



Titolo / Title :

SCHEMA ELETTRICO CWU020 ELECTRICAL DIAGRAM CWU020

FRIULAIR S.r.l. - 33050 CERVIGNANO DEL FRIULI (UD) - ITALY - Via Cisis, 36

Drawing no. :

FQCWU90CWU020Q0000

Rev.

00

Note :

-

Sheet 2 of 10

COMPUTER AIDED DESIGN

This drawing cannot be reproduced, copied or given to third parties without FRIULAIR's written authorization

Questo disegno non può essere copiato, riprodotto né ceduto a terzi senza autorizzazione scritta della FRIULAIR S.r.l.

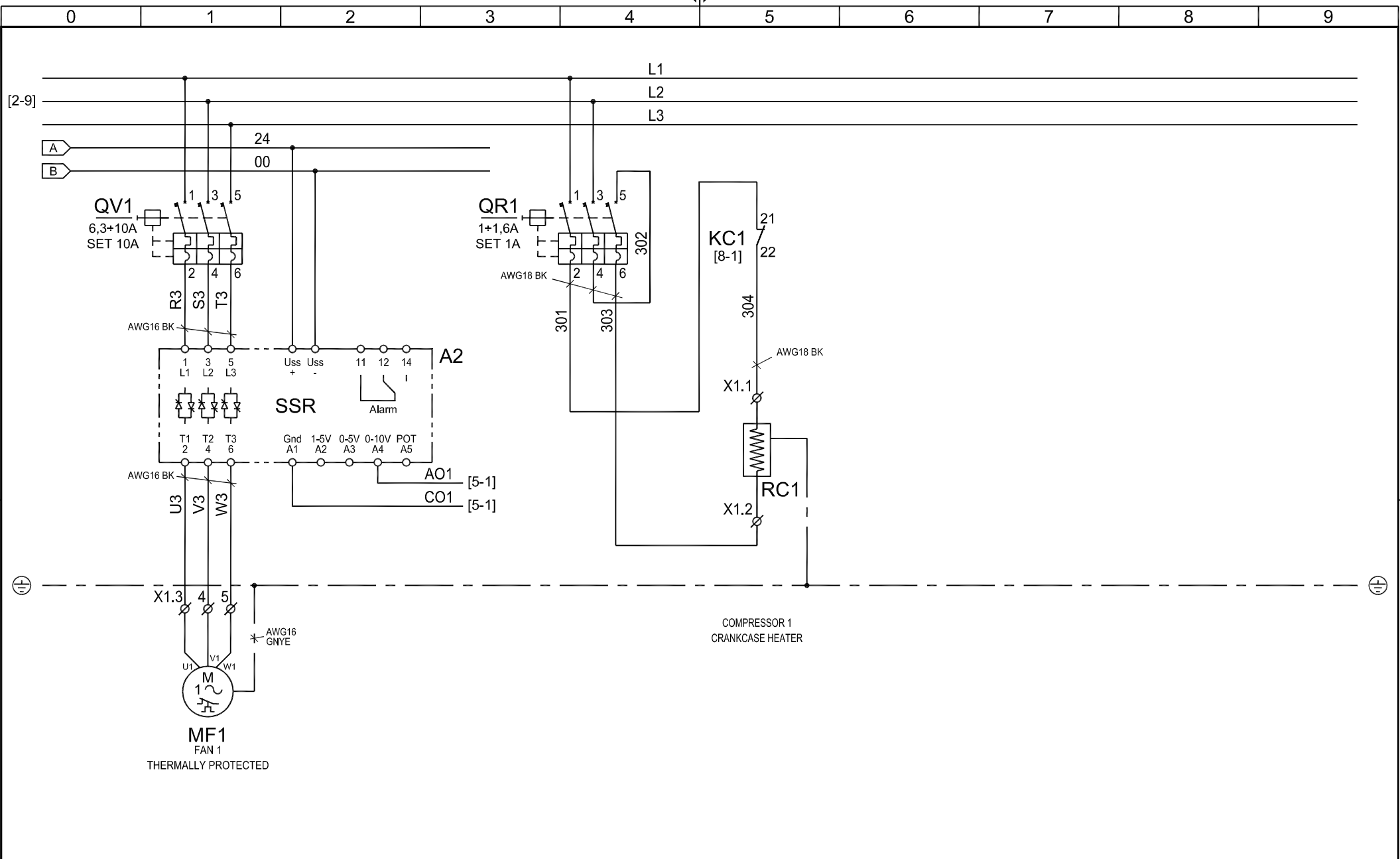

Unless specified AWG18 RD
 Technical modifications are subject to change without notice; errors not excluded



Titolo / Title : **SCHEMA ELETTRICO CWU020**
ELECTRICAL DIAGRAM CWU020
 FRIULAIR S.r.l. - 33050 CERVIGNANO DEL FRIULI (UD) - ITALY - Via Cisis, 36

Drawing no. : **FQCWU90CWU020Q0000** Rev. **00**
 Note :
 - Sheet **3** of **10**

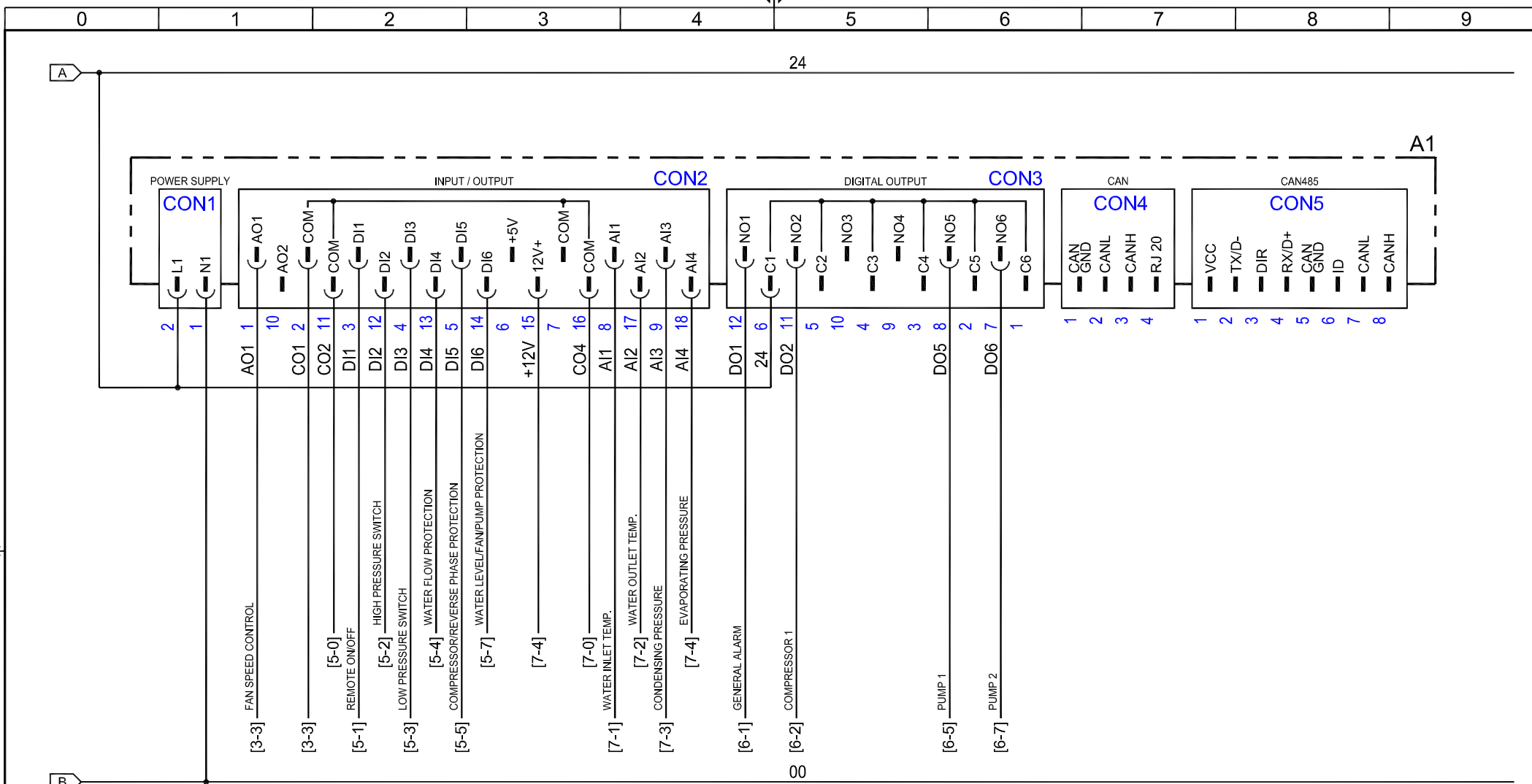

Technical modifications are subject to change without notice; errors not excluded



Titolo / Title :

SCHEMA ELETTRICO CWU020 ELECTRICAL DIAGRAM CWU020

FRIULAIR S.r.l. - 33050 CERVIGNANO DEL FRIULI (UD) - ITALY - Via Cisis, 36

Drawing no. : FQCWU90CWU020Q0000

Rev. 00

Note :

-

Sheet 4 of 10

This drawing cannot be reproduced, copied or given to third parties without FRIULAIR's written authorization

Questo disegno non può essere copiato, riprodotto né ceduto a terzi senza autorizzazione scritta della FRIULAIR S.r.l.

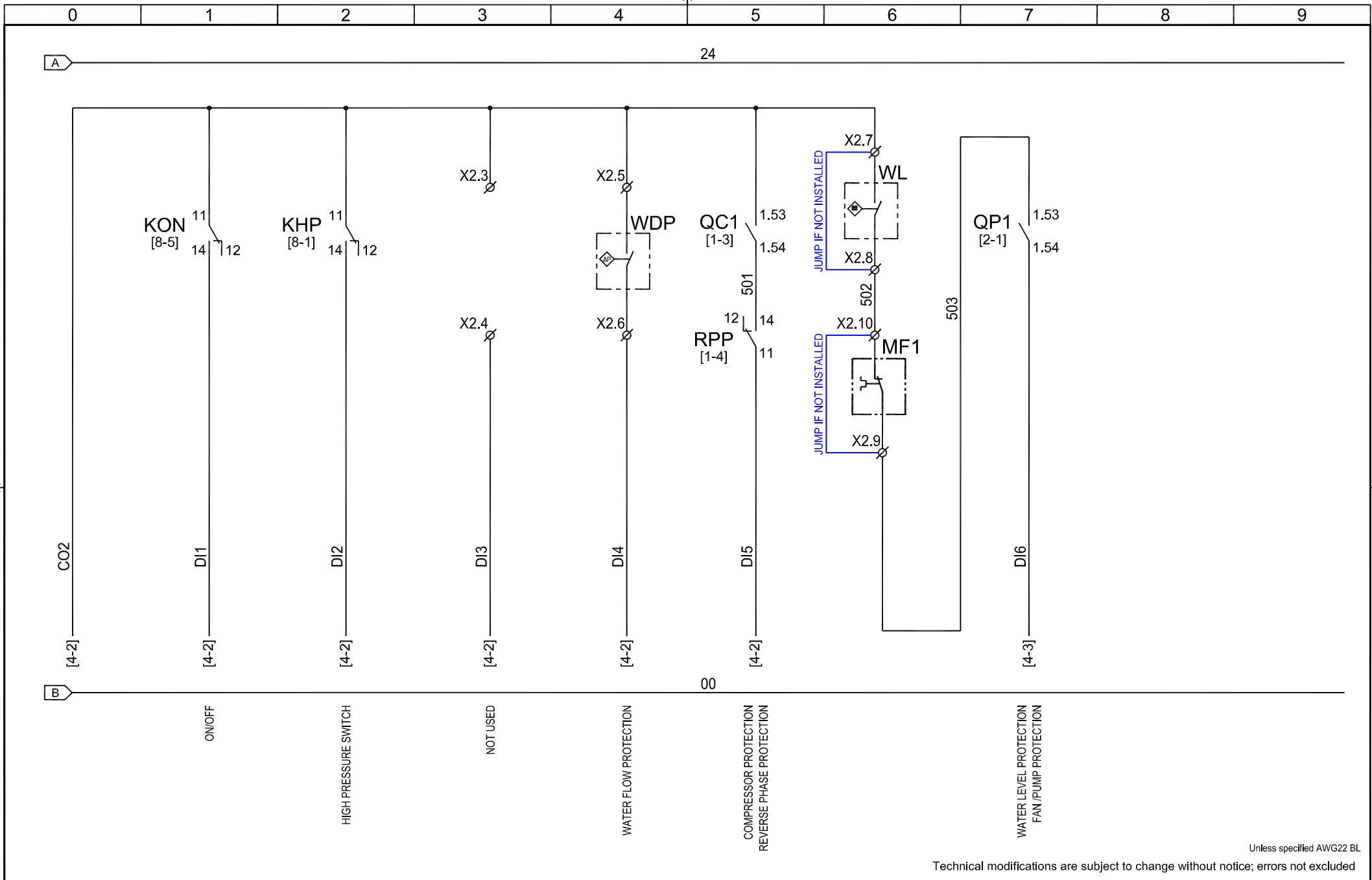

Unless specified AWG22 BL
 Technical modifications are subject to change without notice; errors not excluded



Titolo / Title : **SCHEMA ELETTRICO CWU020**
ELECTRICAL DIAGRAM CWU020
 FRIULAIR S.r.l. - 33050 CERVIGNANO DEL FRIULI (UD) - ITALY - Via Cisis, 36

Drawing no. : **FQCWU90CWU020Q0000** Rev. **00**
 Note :
 - Sheet **5** of **10**

This drawing cannot be reproduced, copied or given to third parties without FRIULAIR's written authorization

Questo disegno non può essere copiato, riprodotto né ceduto a terzi senza autorizzazione scritta della FRIULAIR S.r.l.

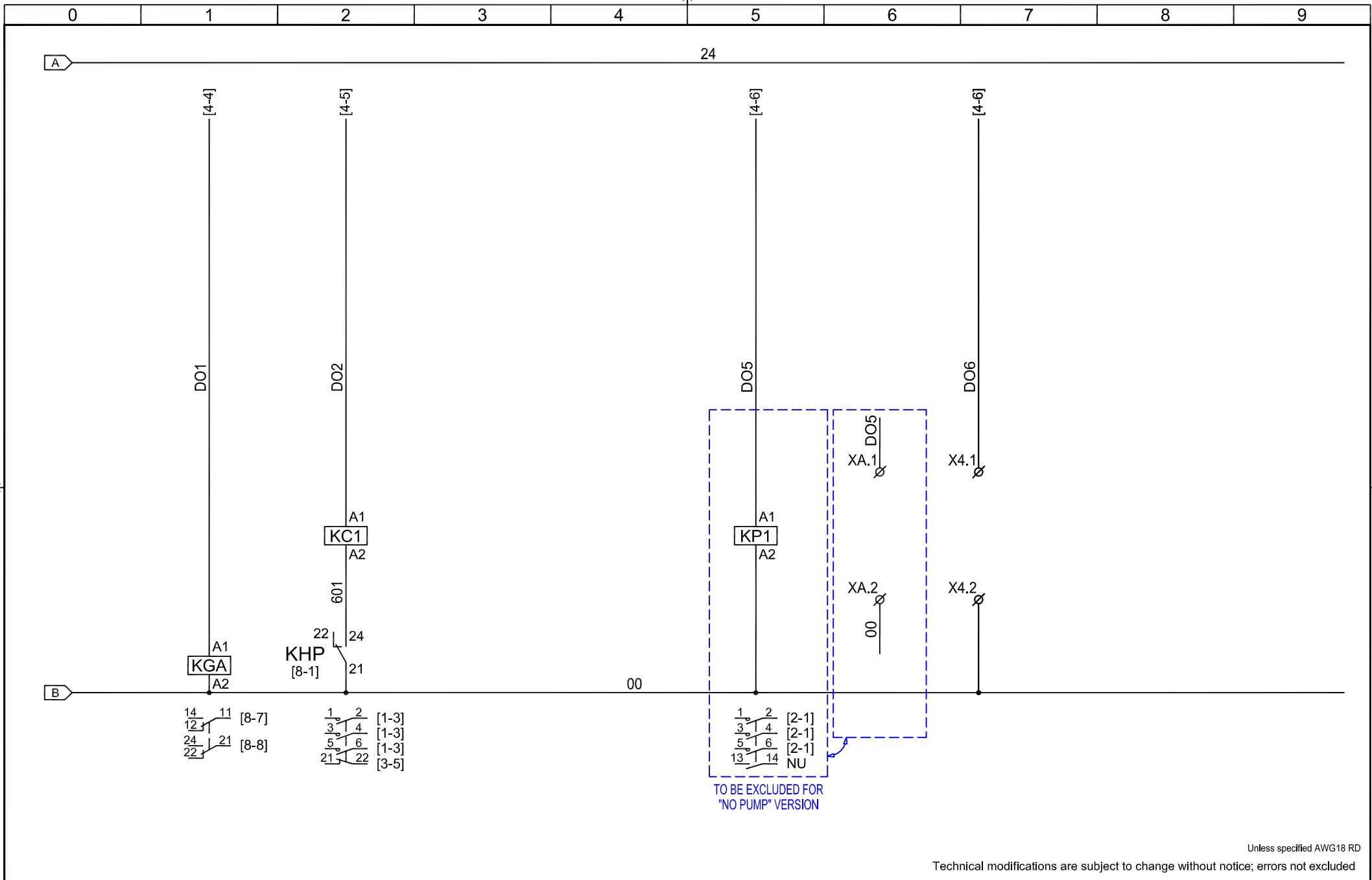

Unless specified AWG18 RD
 Technical modifications are subject to change without notice; errors not excluded



Titolo / Title : **SCHEMA ELETTRICO CWU020**
ELECTRICAL DIAGRAM CWU020
 FRIULAIR S.r.l. - 33050 CERVIGNANO DEL FRIULI (UD) - ITALY - Via Cisis, 36

Drawing no. : **FQCWU90CWU020Q0000** Rev. **00**
 Note :
 - Sheet **6** of **10**

This drawing cannot be reproduced, copied or given to third parties without FRIULAIR's written authorization

Questo disegno non può essere copiato, riprodotto né ceduto a terzi senza autorizzazione scritta della FRIULAIR S.r.l.

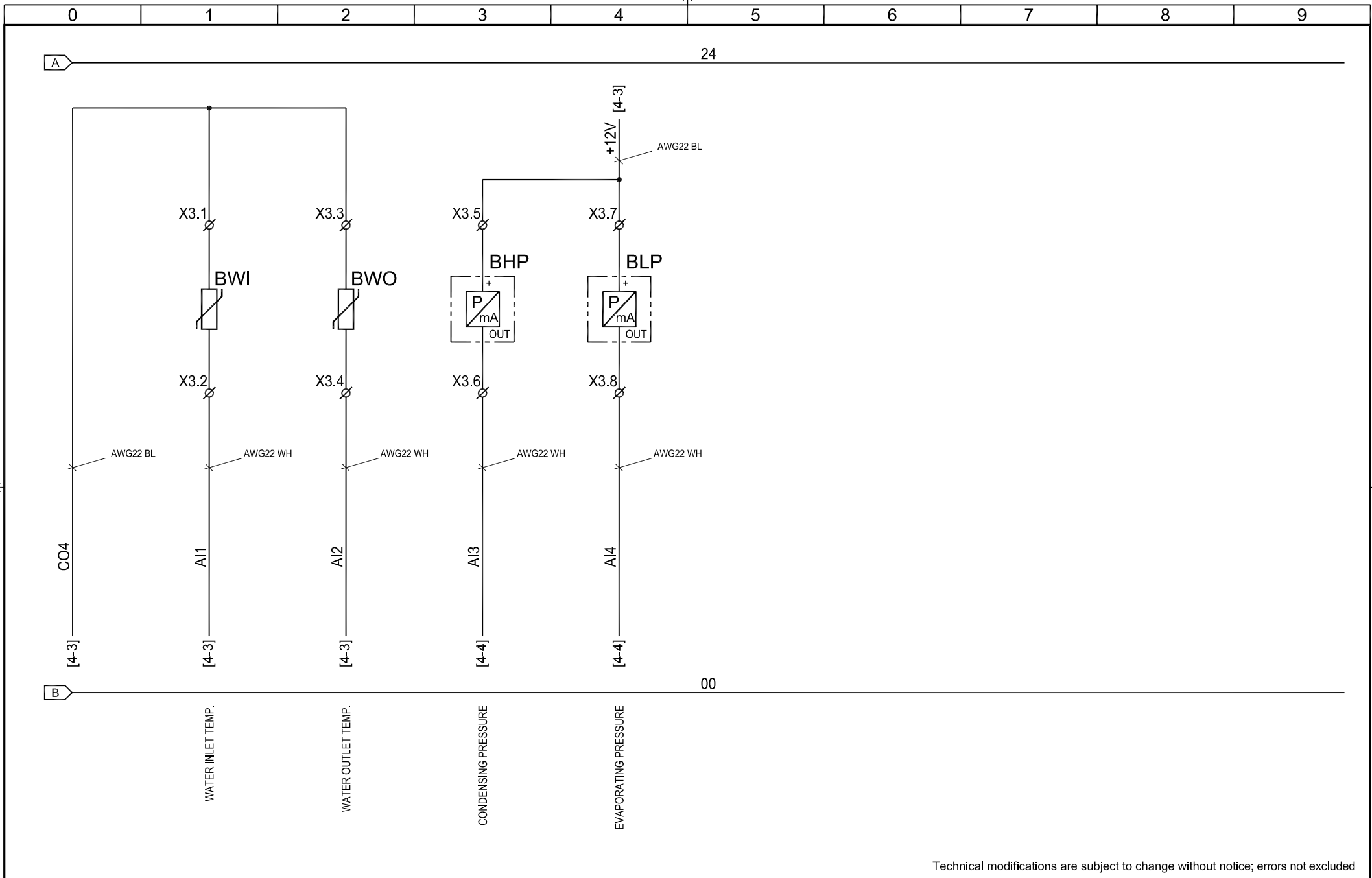

Technical modifications are subject to change without notice; errors not excluded



Titolo / Title :

SCHEMA ELETTRICO CWU020 ELECTRICAL DIAGRAM CWU020

FRIULAIR S.r.l. - 33050 CERVIGNANO DEL FRIULI (UD) - ITALY - Via Cisis, 36

Drawing no. :
FQCWU90CWU020Q0000

Rev.
00

Note :

-

Sheet 7 of 10

COMPUTER AIDED DESIGN

This drawing cannot be reproduced, copied or given to third parties without FRIULAIR's written authorization

Questo disegno non può essere copiato, riprodotto né ceduto a terzi senza autorizzazione scritta della FRIULAIR S.r.l.

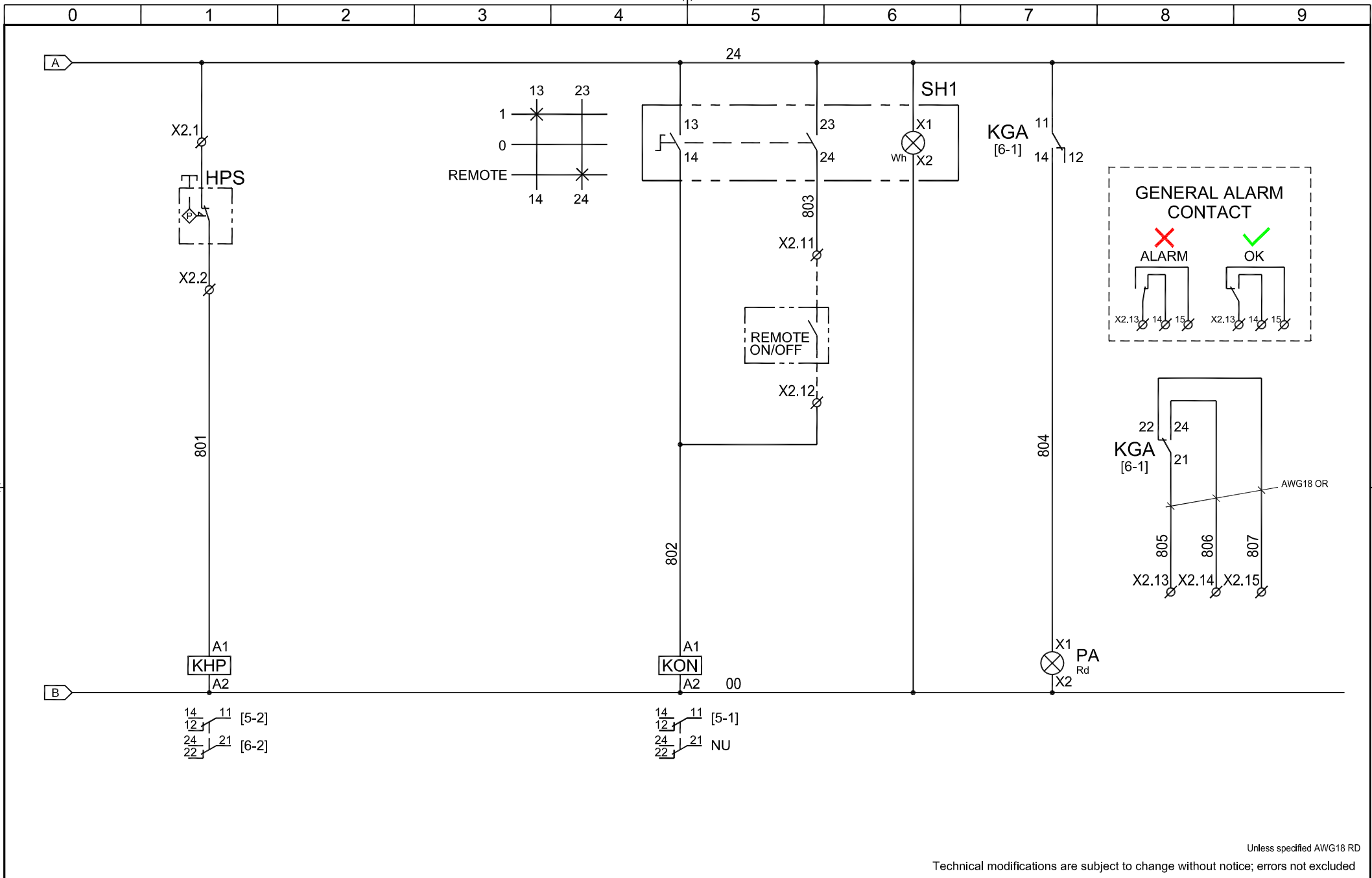

Unless specified AWG18 RD
 Technical modifications are subject to change without notice; errors not excluded



Titolo / Title : **SCHEMA ELETTRICO CWU020**
ELECTRICAL DIAGRAM CWU020
 FRIULAIR S.r.l. - 33050 CERVIGNANO DEL FRIULI (UD) - ITALY - Via Cisis, 36

Drawing no. : **FQCWU90CWU020Q0000** Rev. **00**
 Note :
 - Sheet **8** of **10**

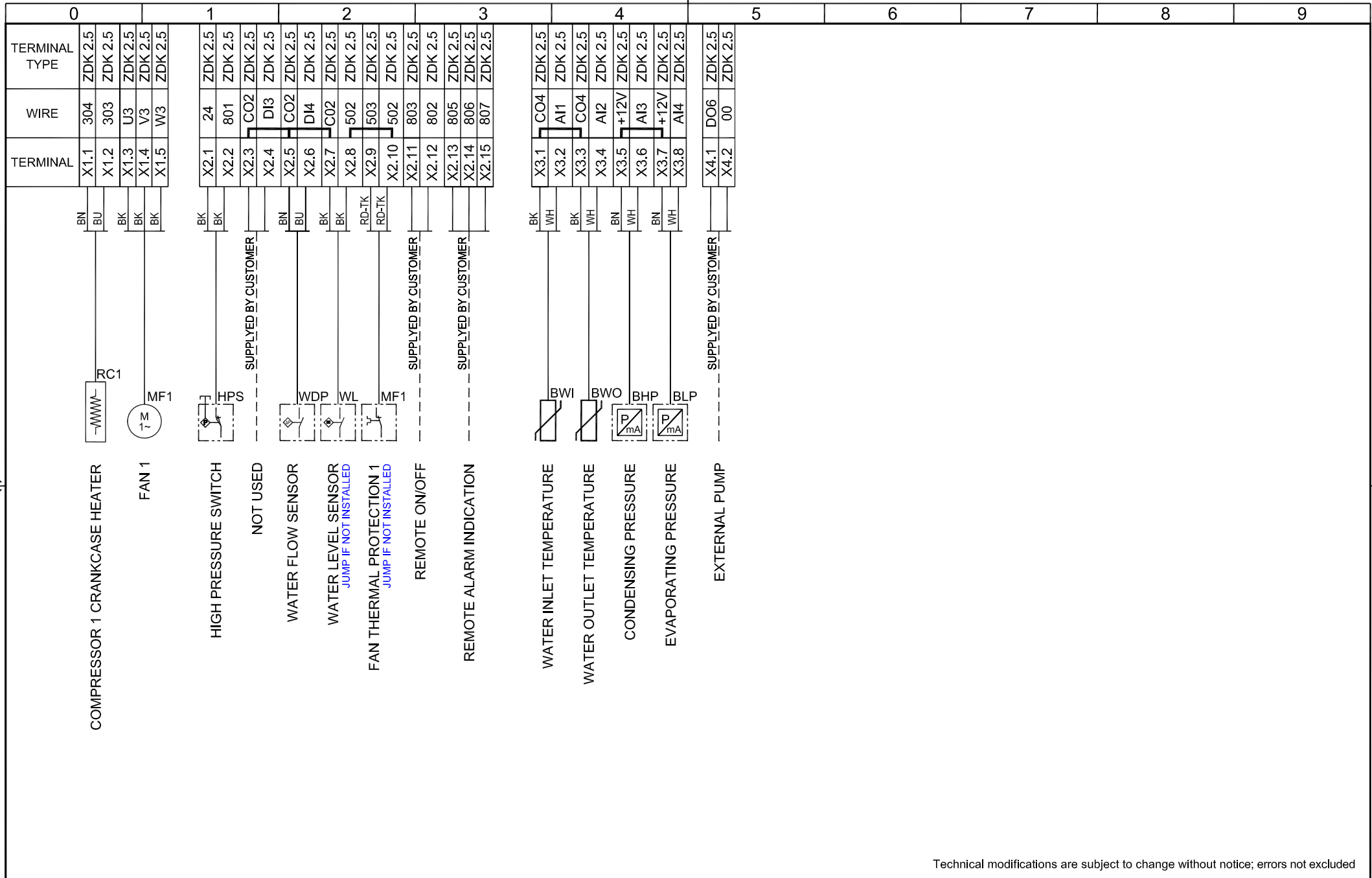

Technical modifications are subject to change without notice; errors not excluded



Titolo / Title :

SCHEMA ELETTRICO CWU020
ELECTRICAL DIAGRAM CWU020

FRIULAIR S.r.l. - 33050 CERVIGNANO DEL FRIULI (UD) - ITALY - Via Cisis, 36

Drawing no. : FQCWU90CWU020Q0000 Rev. 00

Note : -

This drawing cannot be reproduced, copied or given to third parties without FRIULAIR's written authorization

Questo disegno non può essere copiato, riprodotto né ceduto a terzi senza autorizzazione scritta della FRIULAIR S.r.l.

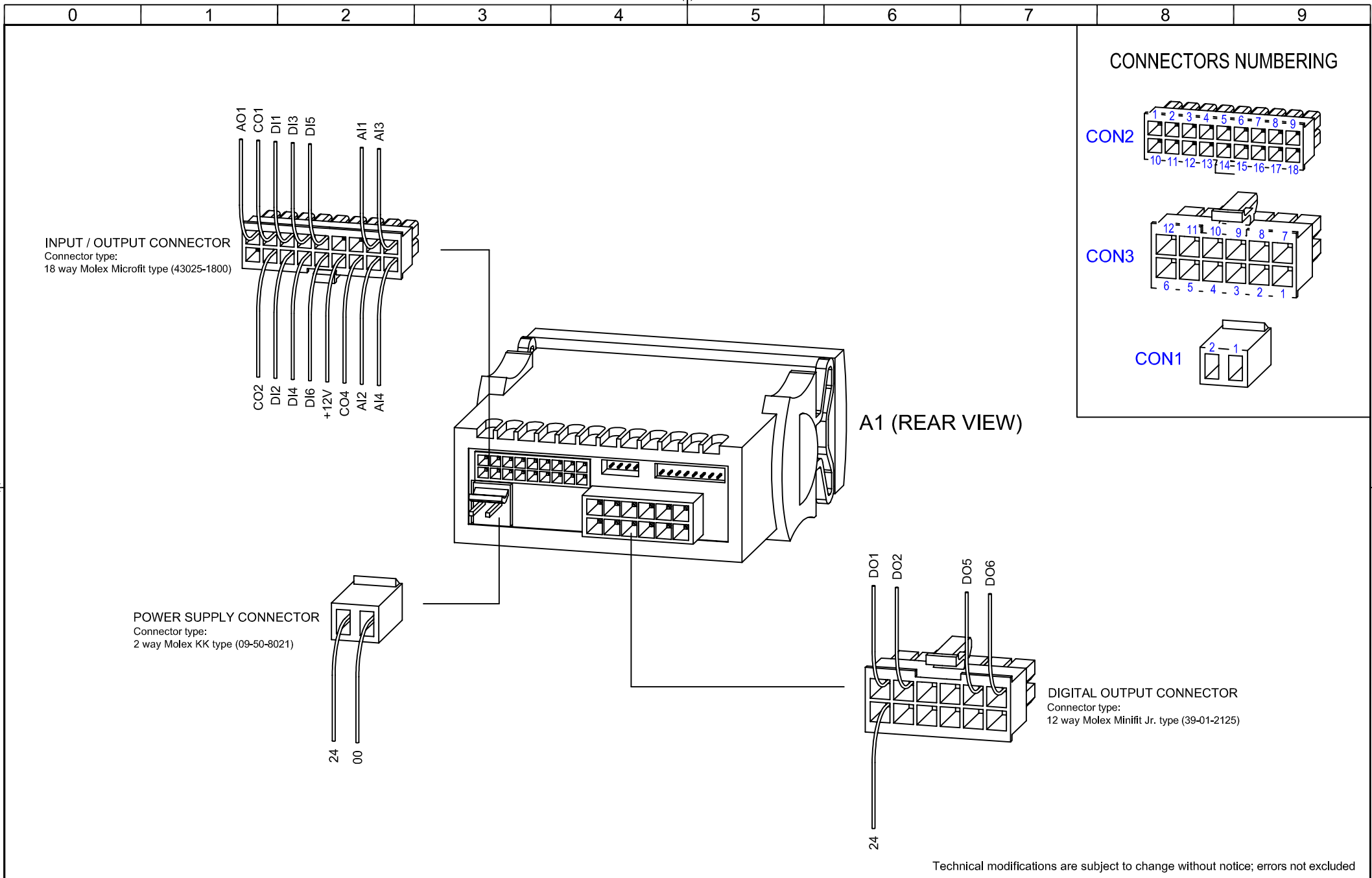

Technical modifications are subject to change without notice; errors not excluded



Titolo / Title : **SCHEMA ELETTRICO CWU020**
ELECTRICAL DIAGRAM CWU020
 FRIULAIR S.r.l. - 33050 CERVIGNANO DEL FRIULI (UD) - ITALY - Via Cisis, 36

Drawing no. : **FQCWU90CWU020Q0000** Rev. **00**
 Note :
 - Sheet **10** of **10**
 COMPUTER AIDED DESIGN

Titolo - Title

SCHEMA ELETTRICO CWU038÷040
ELECTRICAL DIAGRAM CWU038÷040

Disegno n° - Drawing nr.

90CWU040Q0000

Revisione - Revision

01

This drawing cannot be reproduced, copied or given to third parties without FRIULAIR's written authorization

Questo disegno non può essere copiato, riprodotto né ceduto a terzi senza autorizzazione scritta della FRIULAIR S.r.l.

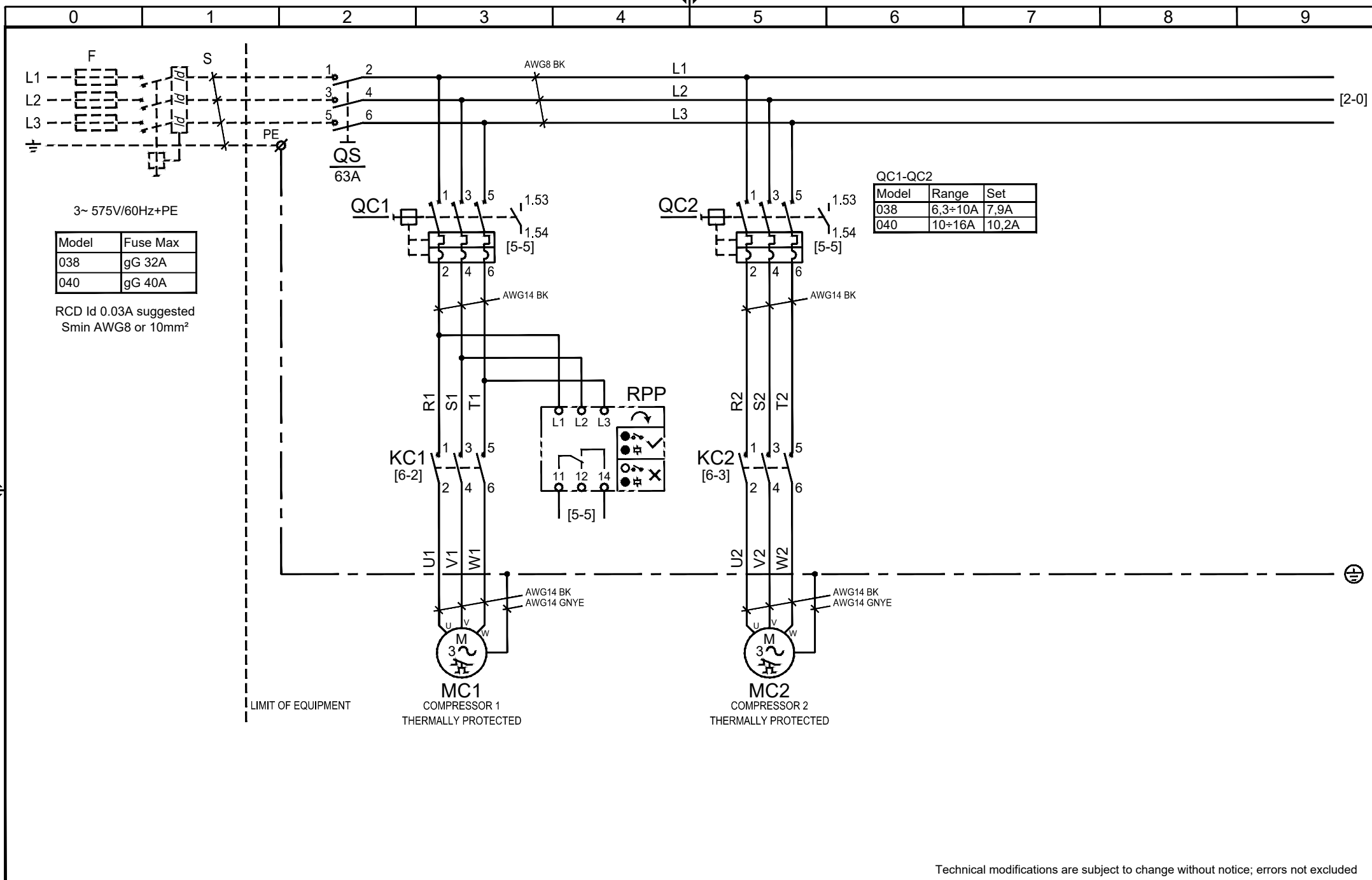

Titolo / Title : **SCHEMA ELETTRICO CWU038÷040**
ELECTRICAL DIAGRAM CWU038÷040

FRIULAIR S.r.l. - 33050 CERVIGNANO DEL FRIULI (UD) - ITALY - Via Cisis, 36

Drawing no. : **90CWU040Q0000** Rev. **01**

Note : -

Sheet **1** of **10**

COMPUTER AIDED DESIGN

This drawing cannot be reproduced, copied or given to third parties without FRIULAIR's written authorization

Questo disegno non può essere copiato, riprodotto né ceduto a terzi senza autorizzazione scritta della FRIULAIR S.r.l.

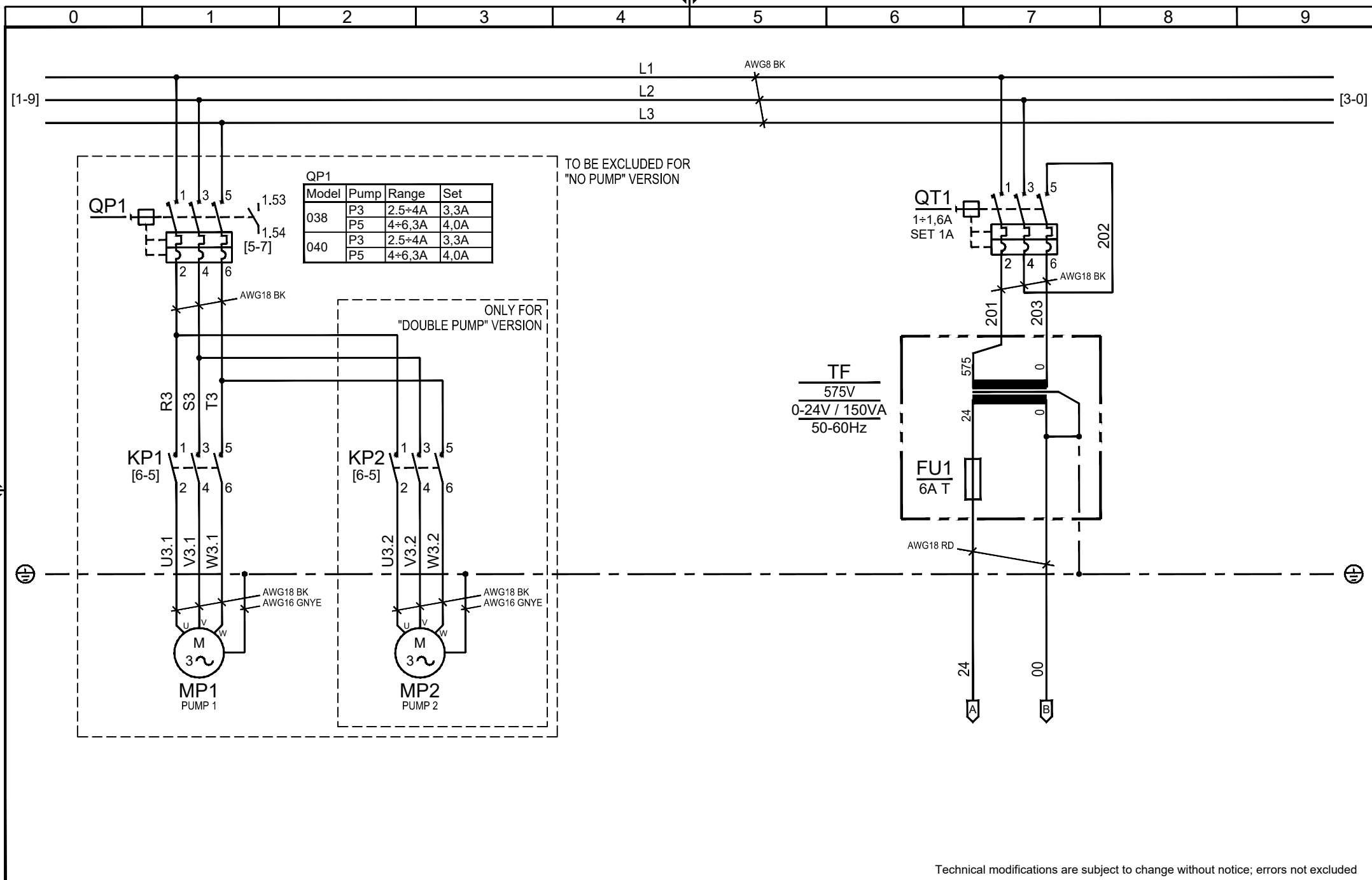

Technical modifications are subject to change without notice; errors not excluded



Titolo / Title : **SCHEMA ELETTRICO CWU038÷040**
ELECTRICAL DIAGRAM CWU038÷040

FRIULAIR S.r.l. - 33050 CERVIGNANO DEL FRIULI (UD) - ITALY - Via Cisis, 36

Drawing no. : **90CWU040Q0000** Rev. **01**
 Note :
 -

Sheet **2** of **10**
 COMPUTER AIDED DESIGN

This drawing cannot be reproduced, copied or given to third parties without FRIULAIR's written authorization

Questo disegno non può essere copiato, riprodotto né ceduto a terzi senza autorizzazione scritta della FRIULAIR S.r.l.

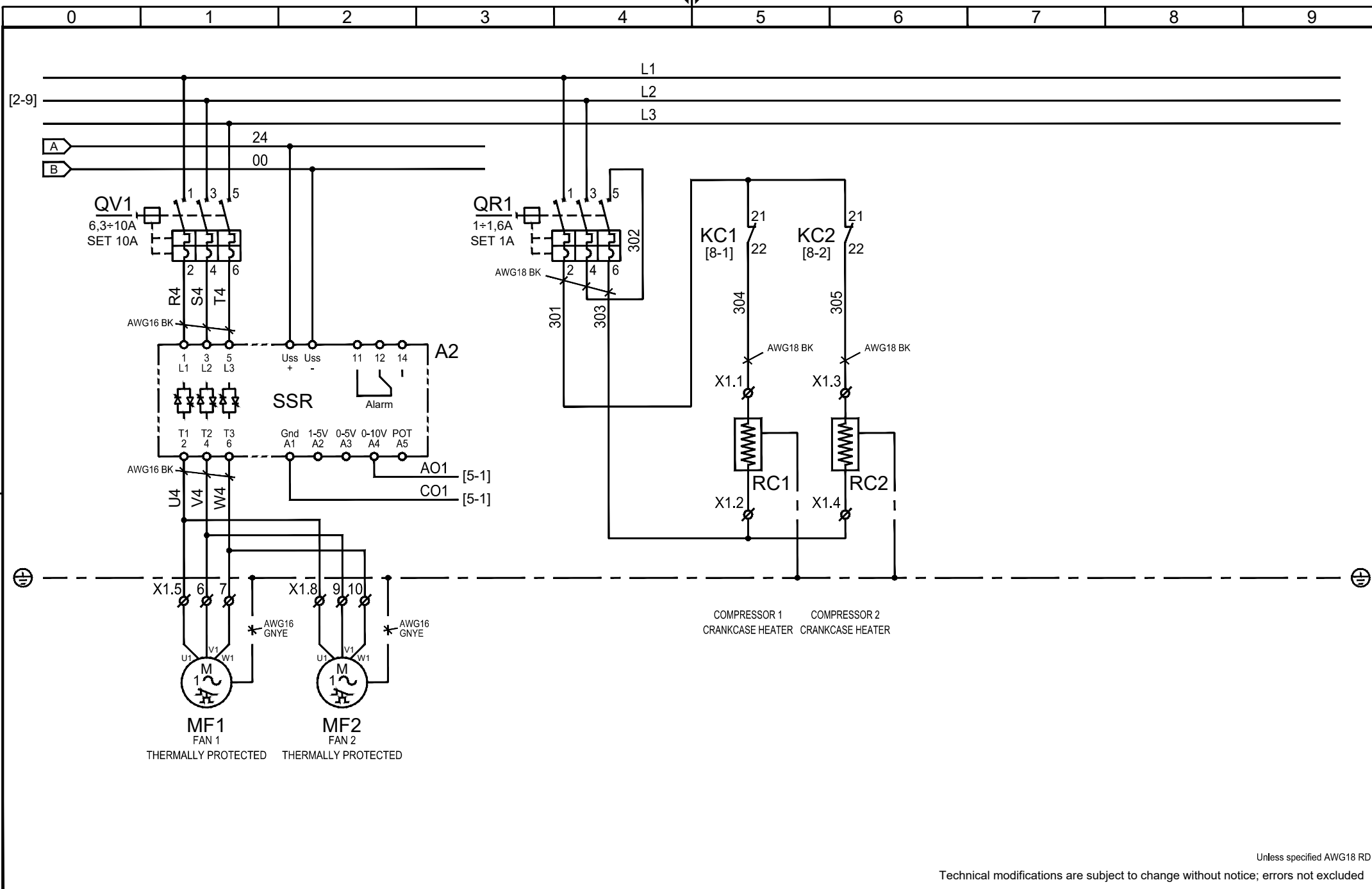

Unless specified AWG18 RD
 Technical modifications are subject to change without notice; errors not excluded



Titolo / Title : **SCHEMA ELETTRICO CWU038÷040**
ELECTRICAL DIAGRAM CWU038÷040
 FRIULAIR S.r.l. - 33050 CERVIGNANO DEL FRIULI (UD) - ITALY - Via Cisis, 36

Drawing no. : **90CWU040Q0000** Rev. **01**
 Note :
 - Sheet **3** of **10**
 COMPUTER AIDED DESIGN

This drawing cannot be reproduced, copied or given to third parties without FRIULAIR's written authorization

Questo disegno non può essere copiato, riprodotto né ceduto a terzi senza autorizzazione scritta della FRIULAIR S.r.l.

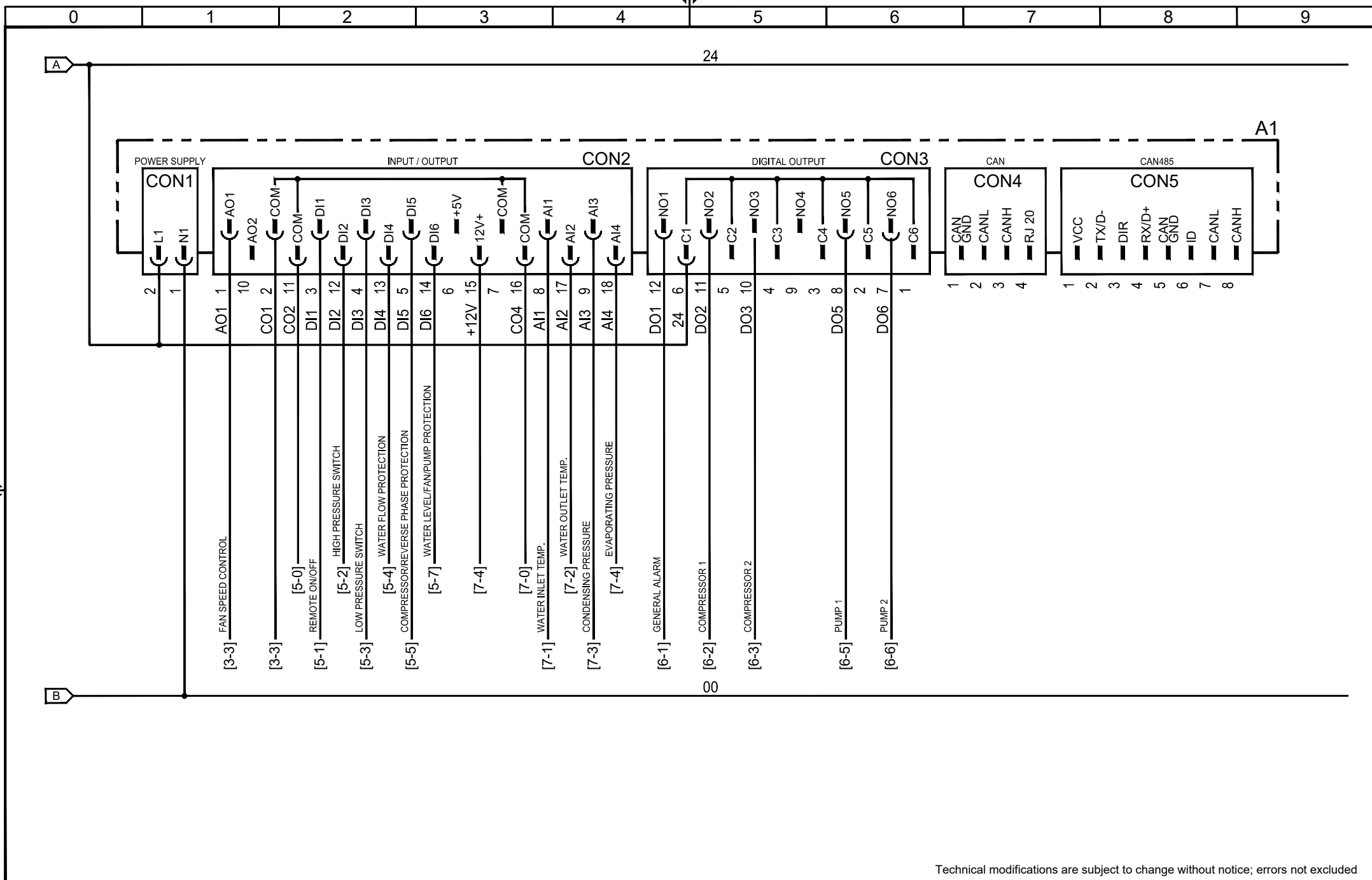

Technical modifications are subject to change without notice; errors not excluded



Titolo / Title : **SCHEMA ELETTRICO CWU038÷040**
ELECTRICAL DIAGRAM CWU038÷040
 FRIULAIR S.r.l. - 33050 CERVIGNANO DEL FRIULI (UD) - ITALY - Via Cisis, 36

Drawing no. : **90CWU040Q0000** Rev. **01**
 Note : -
 Sheet **4** of **10**
 COMPUTER AIDED DESIGN

This drawing cannot be reproduced, copied or given to third parties without FRIULAIR's written authorization

Questo disegno non può essere copiato, riprodotto né ceduto a terzi senza autorizzazione scritta della FRIULAIR S.r.l.

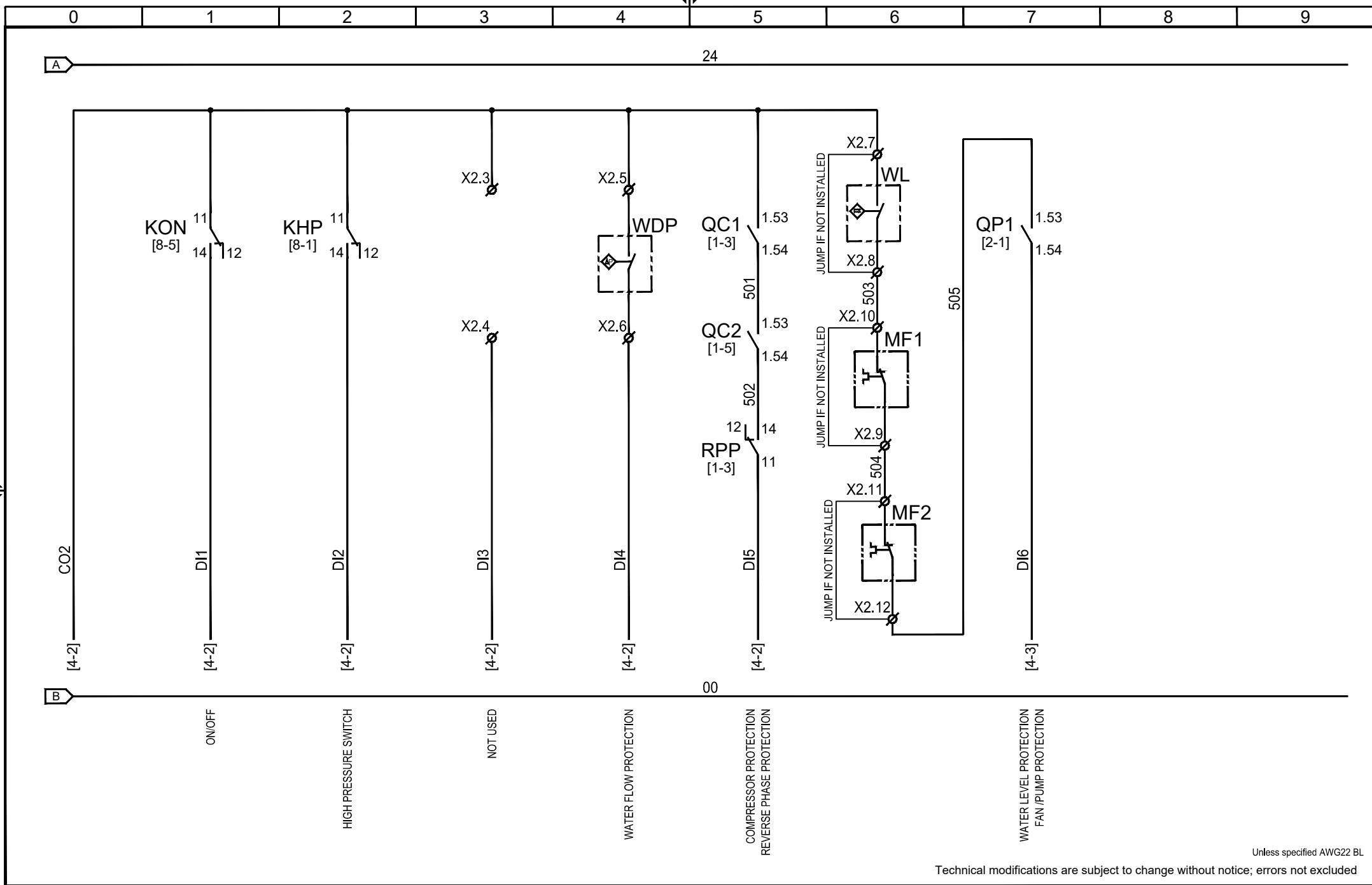

Unless specified AWG22 BL
 Technical modifications are subject to change without notice; errors not excluded



Titolo / Title : **SCHEMA ELETTRICO CWU038÷040**
ELECTRICAL DIAGRAM CWU038÷040
 FRIULAIR S.r.l. - 33050 CERVIGNANO DEL FRIULI (UD) - ITALY - Via Cisis, 36

Drawing no. : **90CWU040Q0000** Rev. **01**
 Note : -
 Sheet **5** of **10**
 COMPUTER AIDED DESIGN

This drawing cannot be reproduced, copied or given to third parties without FRIULAIR's written authorization

Questo disegno non può essere copiato, riprodotto né ceduto a terzi senza autorizzazione scritta della FRIULAIR S.r.l.

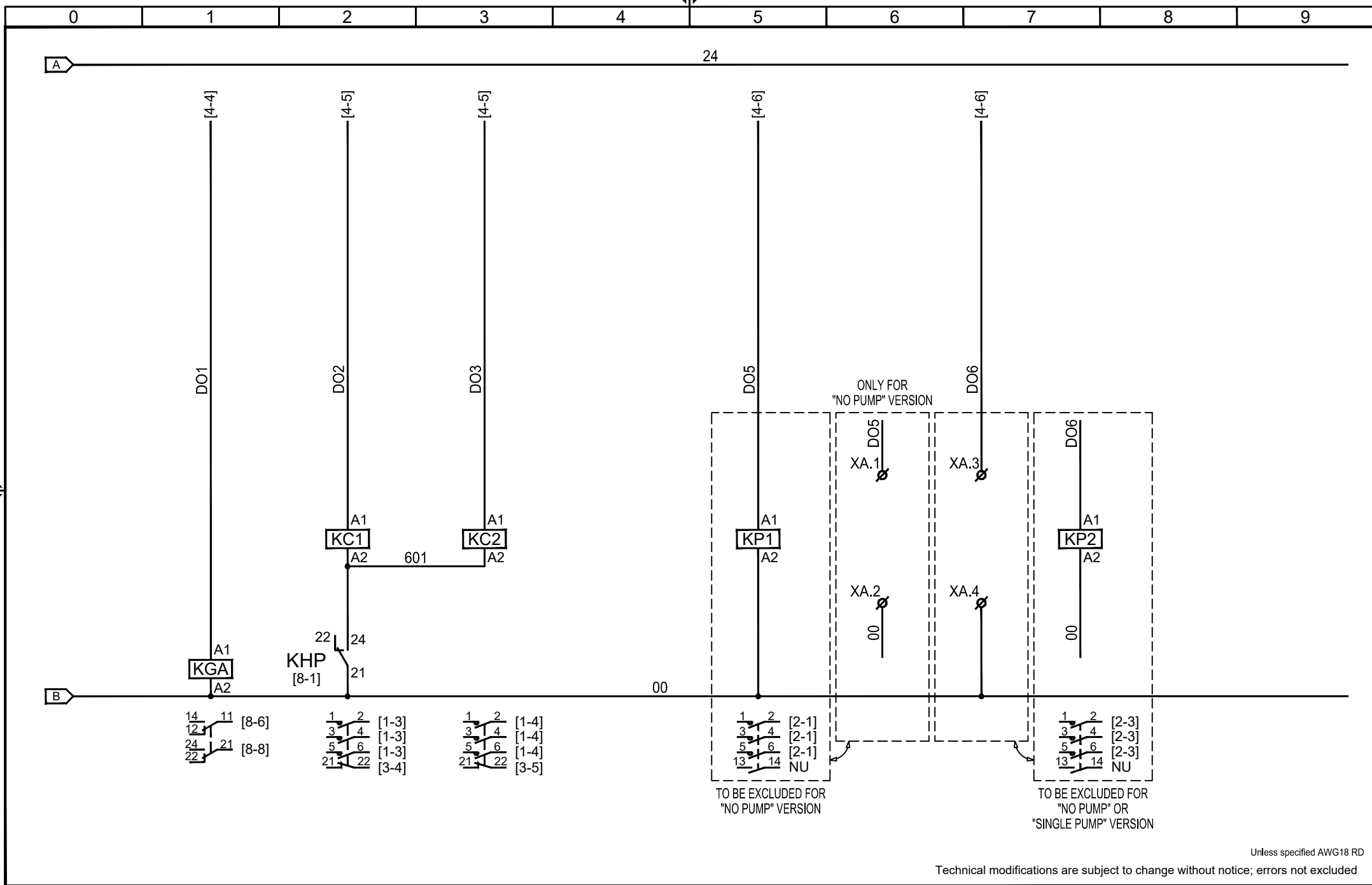

Unless specified AWG18 RD
Technical modifications are subject to change without notice; errors not excluded



Titolo / Title : **SCHEMA ELETTRICO CWU038÷040**
ELECTRICAL DIAGRAM CWU038÷040
 FRIULAIR S.r.l. - 33050 CERVIGNANO DEL FRIULI (UD) - ITALY - Via Cisis, 36

Drawing no. : **90CWU040Q0000** Rev. **01**
 Note : -
 Sheet **6** of **10**
 COMPUTER AIDED DESIGN

This drawing cannot be reproduced, copied or given to third parties without FRIULAIR's written authorization

Questo disegno non può essere copiato, riprodotto né ceduto a terzi senza autorizzazione scritta della FRIULAIR S.r.l.

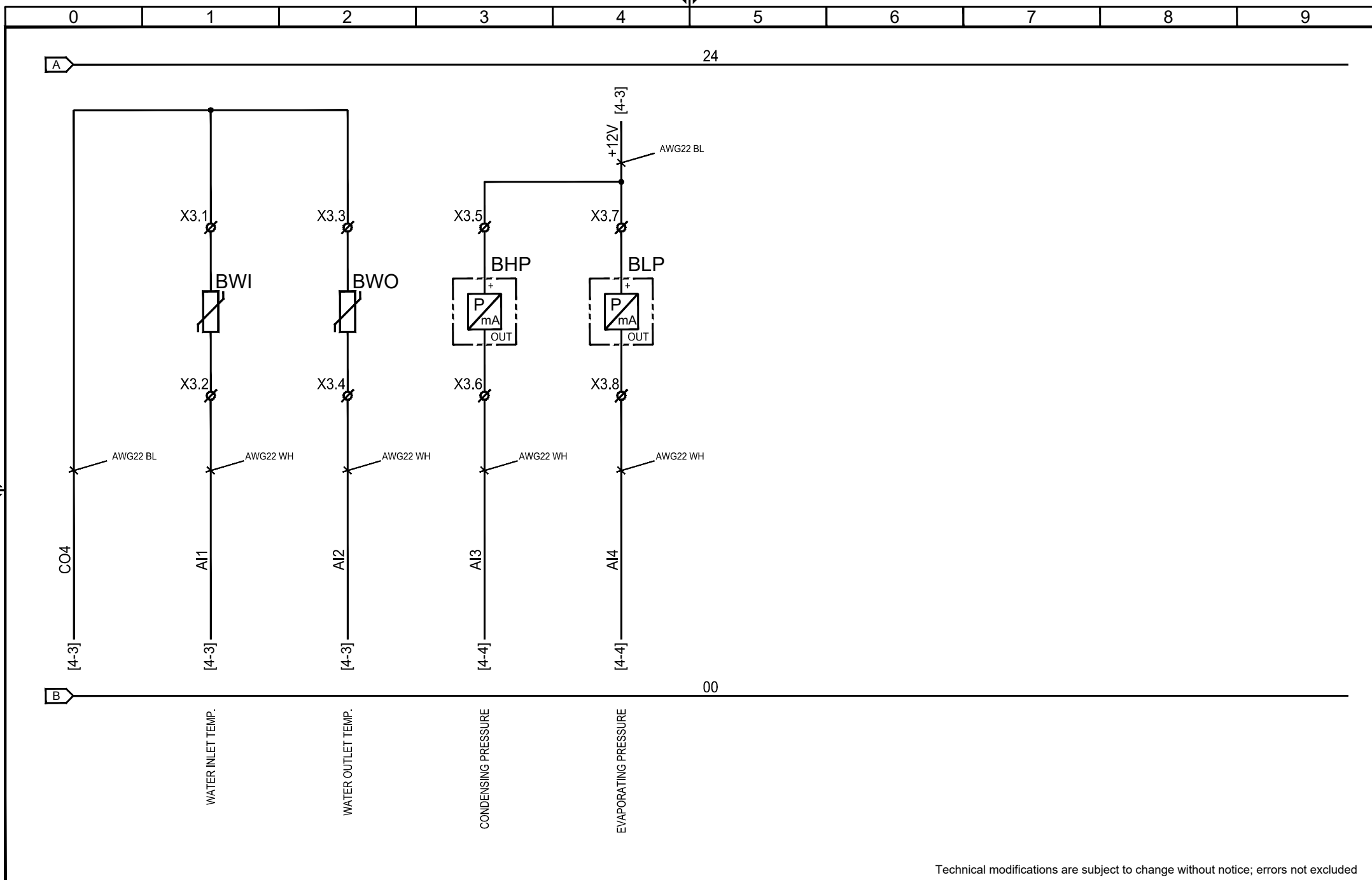

Technical modifications are subject to change without notice; errors not excluded



Titolo / Title :

SCHEMA ELETTRICO CWU038÷040 ELECTRICAL DIAGRAM CWU038÷040

FRIULAIR S.r.l. - 33050 CERVIGNANO DEL FRIULI (UD) - ITALY - Via Cisis, 36

Drawing no. :
90CWU040Q0000

Rev.
01

Note :

-

Sheet 7 of 10

COMPUTER AIDED DESIGN

This drawing cannot be reproduced, copied or given to third parties without FRIULAIR's written authorization

Questo disegno non può essere copiato, riprodotto né ceduto a terzi senza autorizzazione scritta della FRIULAIR S.r.l.

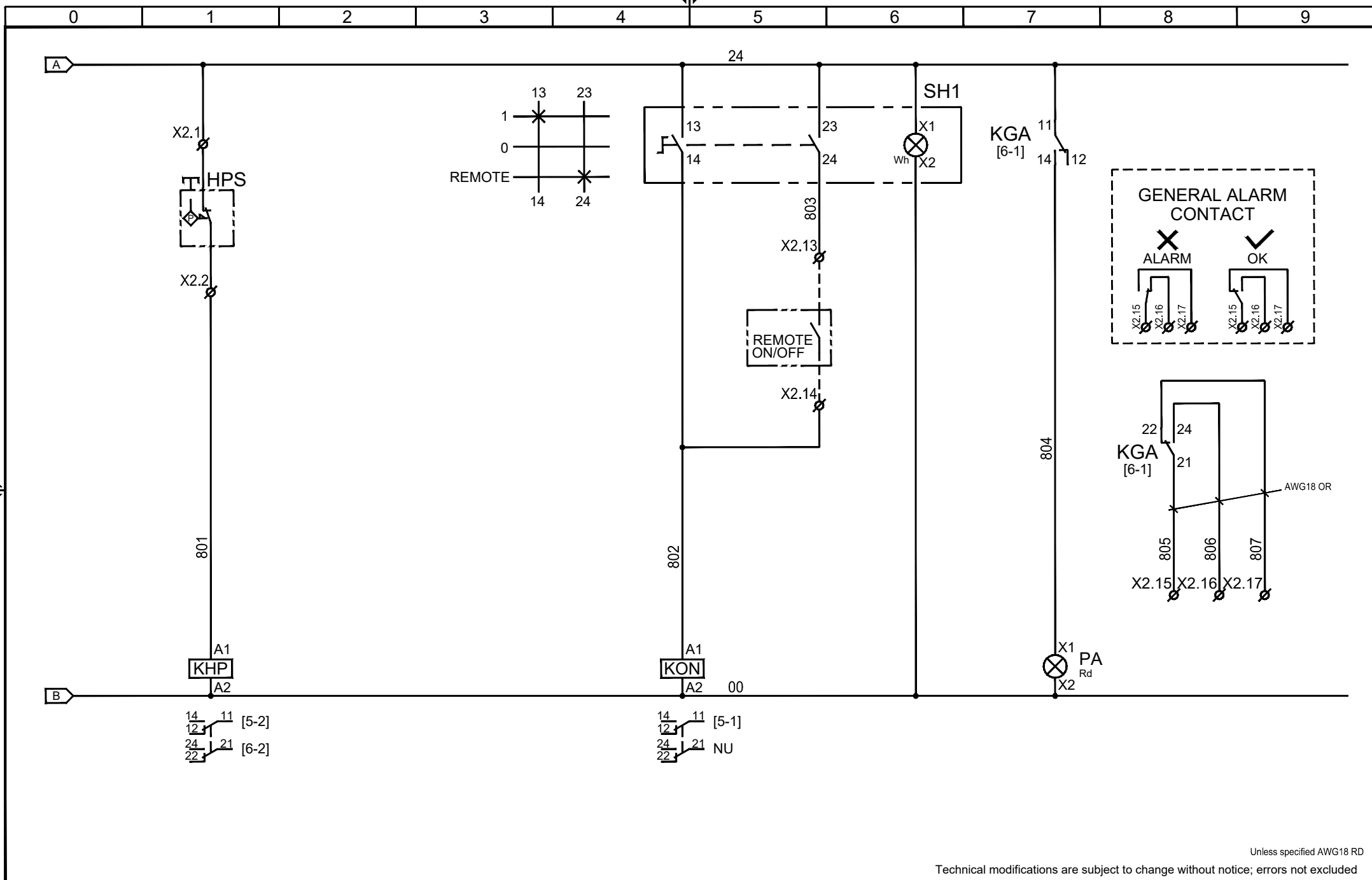

Unless specified AWG18 RD
 Technical modifications are subject to change without notice; errors not excluded



Titolo / Title : **SCHEMA ELETTRICO CWU038÷040**
ELECTRICAL DIAGRAM CWU038÷040
 FRIULAIR S.r.l. - 33050 CERVIGNANO DEL FRIULI (UD) - ITALY - Via Cisis, 36

Drawing no. : **90CWU040Q0000** Rev. **01**
 Note :
 - Sheet **8** of **10**
 COMPUTER AIDED DESIGN

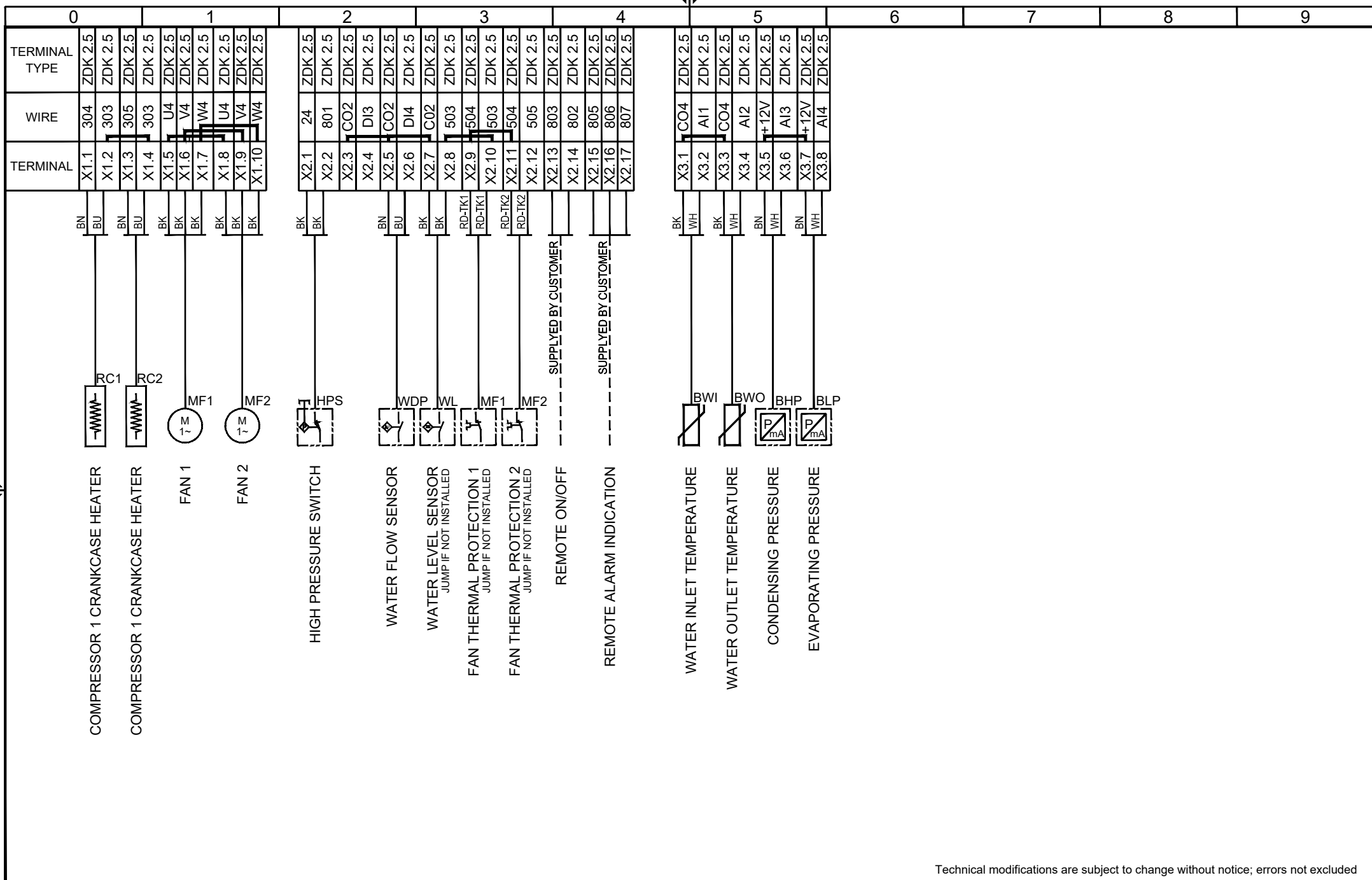

Technical modifications are subject to change without notice; errors not excluded



Titolo / Title :

SCHEMA ELETTRICO CWU038÷040
ELECTRICAL DIAGRAM CWU038÷040

FRIULAIR S.r.l. - 33050 CERVIGNANO DEL FRIULI (UD) - ITALY - Via Cisis, 36

Drawing no. :
 90CWU040Q0000

Rev.
 01

Note :

-

This drawing cannot be reproduced, copied or given to third parties without FRIULAIR's written authorization

Questo disegno non può essere copiato, riprodotto né ceduto a terzi senza autorizzazione scritta della FRIULAIR S.r.l.

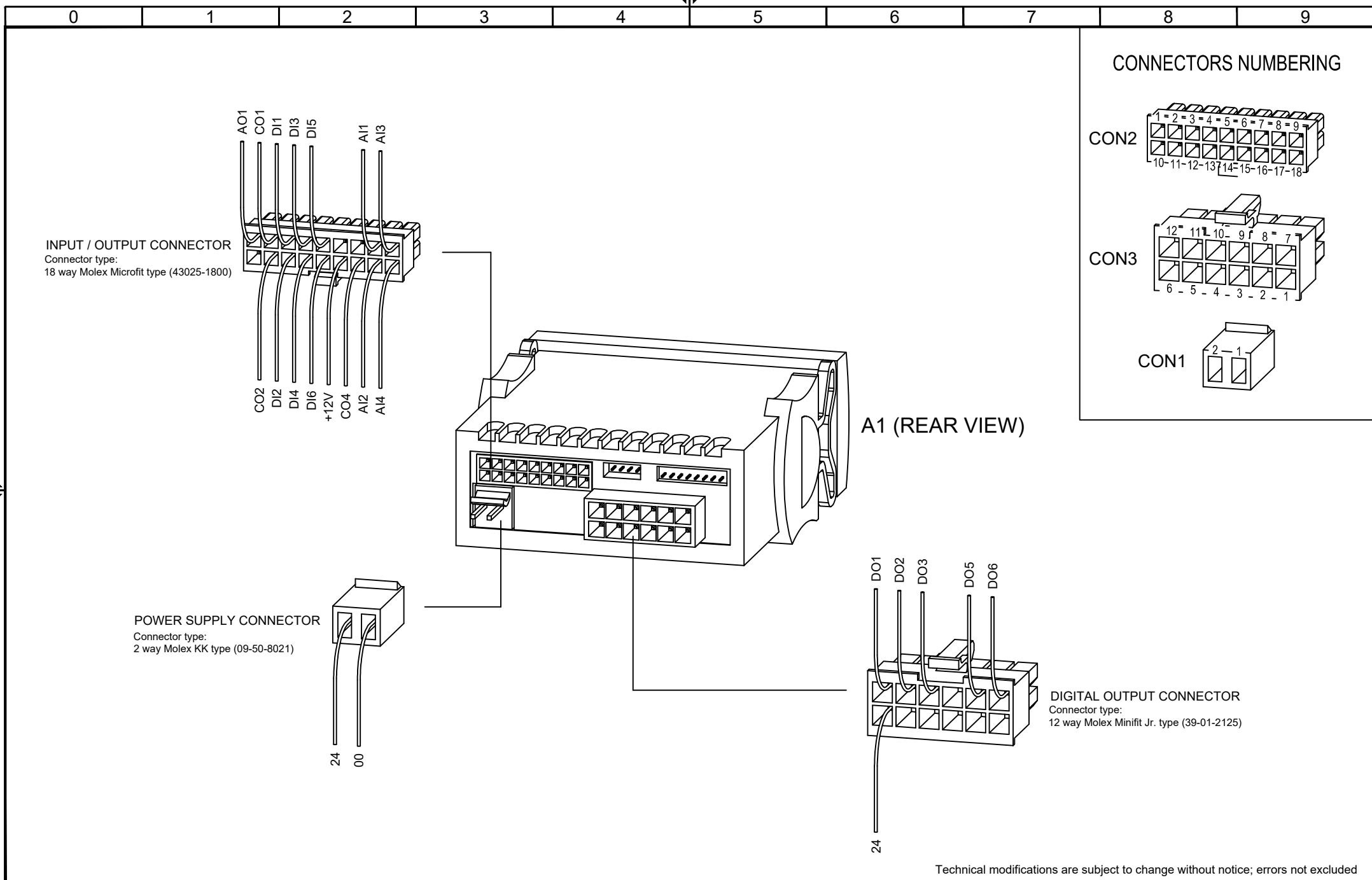

Technical modifications are subject to change without notice; errors not excluded



Titolo / Title : **SCHEMA ELETTRICO CWU038÷040**
ELECTRICAL DIAGRAM CWU038÷040

FRIULAIR S.r.l. - 33050 CERVIGNANO DEL FRIULI (UD) - ITALY - Via Cisis, 36

Drawing no. : **90CWU040Q000** Rev. **01**

Note : -

Sheet **10** of **10**

COMPUTER AIDED DESIGN

This drawing cannot be reproduced, copied or given to
third parties without FRIULAIR's written authorization

Questo disegno non può essere copiato, riprodotto né ceduto
a terzi senza autorizzazione scritta della FRIULAIR S.r.l.

Titolo - Title

SCHEMA ELETTRICO CWU045÷065
ELECTRICAL DIAGRAM CWU045÷065

Disegno n° - Drawing nr.

FRCWU90CWU065Q0000

Revisione - Revision

00

FRIULAIR
Dryers

FRIULAIR S.r.l. - 33050 CERVIGNANO DEL FRIULI (UD) - ITALY - Via Cisis, 36

This drawing cannot be reproduced, copied or given to third parties without FRIULAIR's written authorization

Questo disegno non può essere copiato, riprodotto né ceduto a terzi senza autorizzazione scritta della FRIULAIR S.r.l.

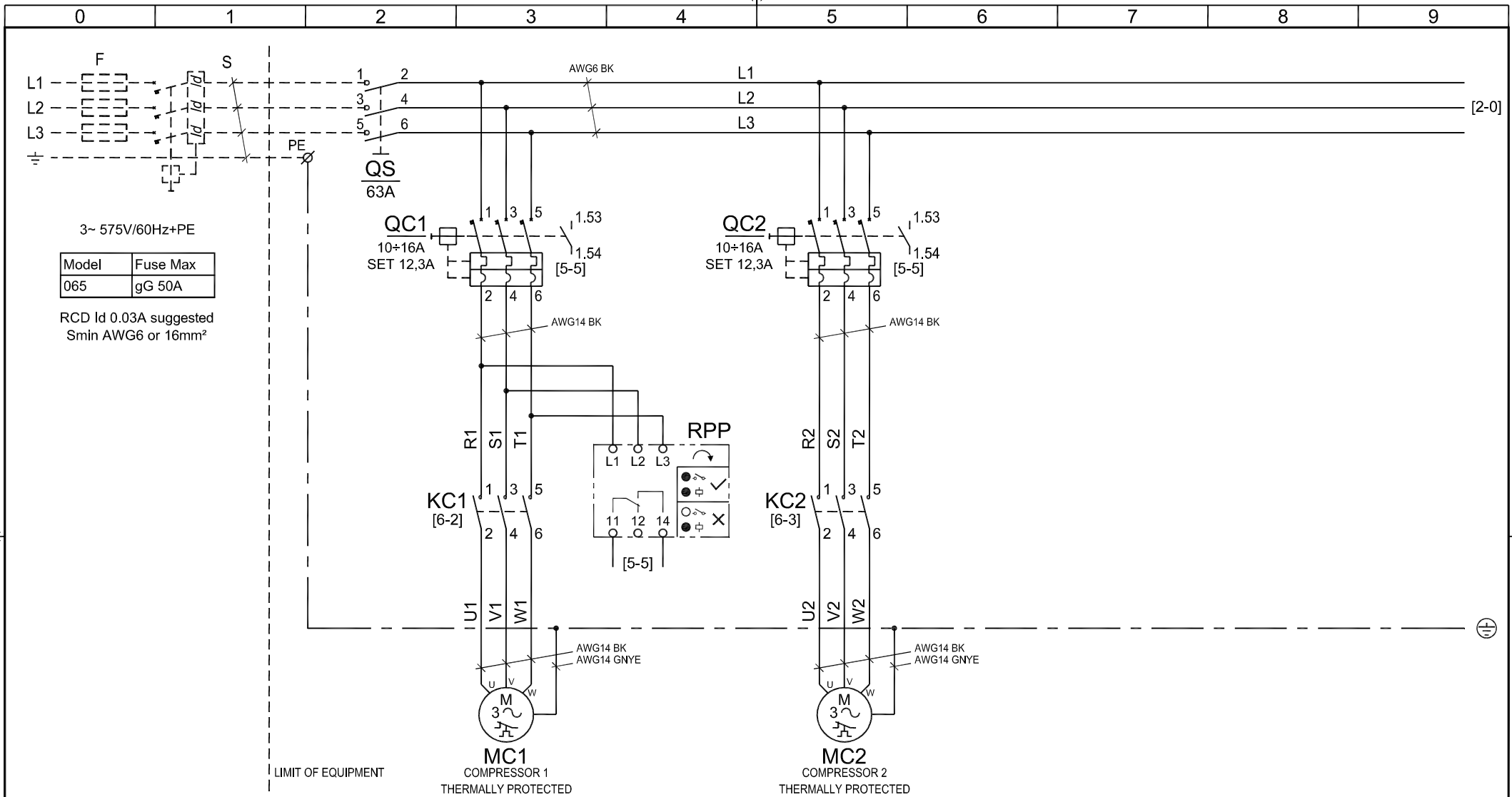

Technical modifications are subject to change without notice; errors not excluded

FRIULAIR
Dryers

Titolo / Title :

SCHEMA ELETTRICO CWU065
ELECTRICAL DIAGRAM CWU065

FRIULAIR S.r.l. - 33050 CERVIGNANO DEL FRIULI (UD) - ITALY - Via Cisis, 36

Drawing no. :
FRCWU90CWU065Q0000

Rev.
00

Note :

-

Sheet 1 of 10

COMPUTER AIDED DESIGN

This drawing cannot be reproduced, copied or given to third parties without FRIULAIR's written authorization

Questo disegno non può essere copiato, riprodotto né ceduto a terzi senza autorizzazione scritta della FRIULAIR S.r.l.

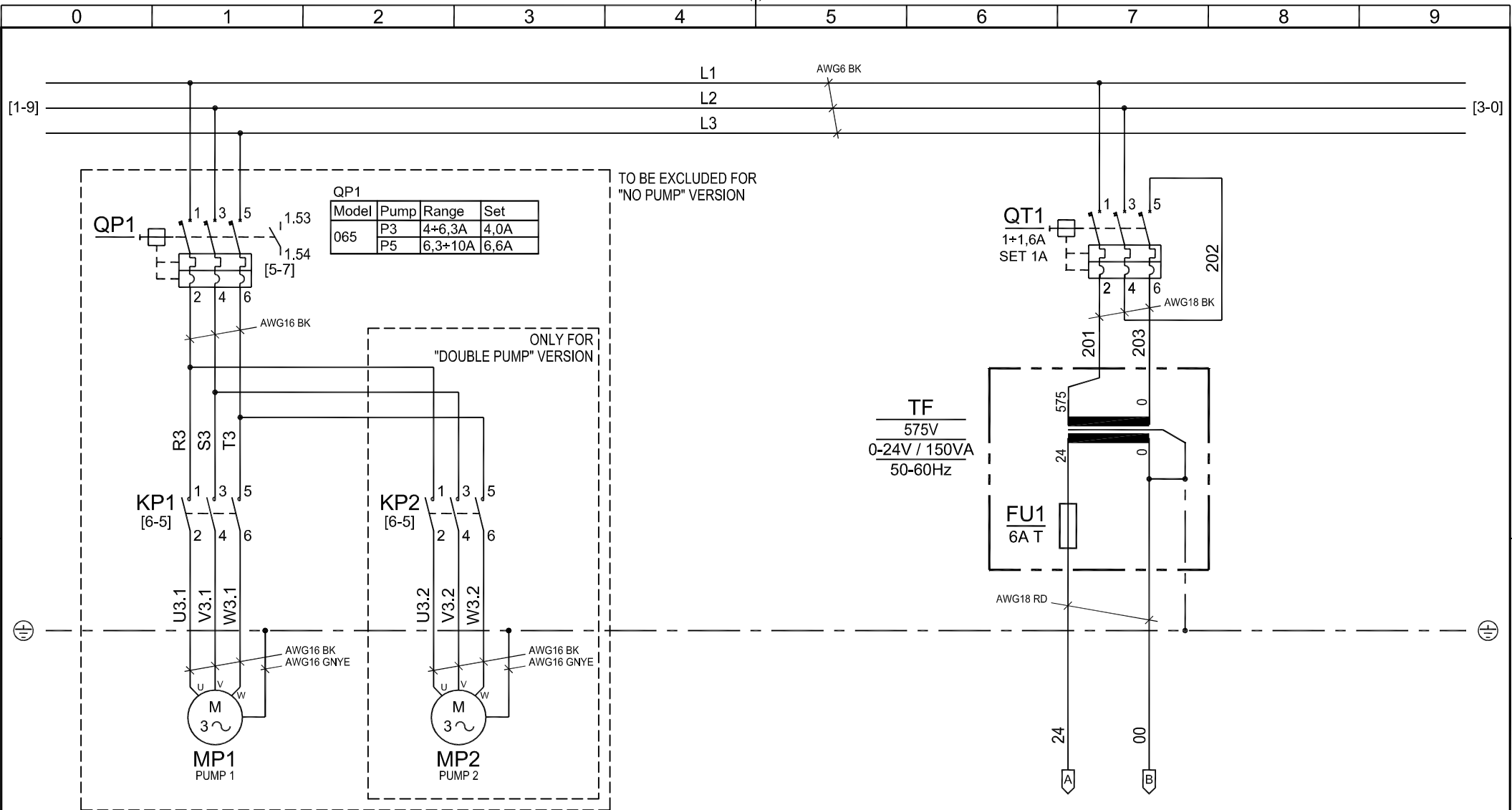

Technical modifications are subject to change without notice; errors not excluded



Titolo / Title :

SCHEMA ELETTRICO CWU065 ELECTRICAL DIAGRAM CWU065

FRIULAIR S.r.l. - 33050 CERVIGNANO DEL FRIULI (UD) - ITALY - Via Cisis, 36

Drawing no. :
FRCWU90CWU065Q0000

Rev.
00

Note :

-

Sheet 2 of 10

COMPUTER AIDED DESIGN

This drawing cannot be reproduced, copied or given to third parties without FRIULAIR's written authorization

Questo disegno non può essere copiato, riprodotto né ceduto a terzi senza autorizzazione scritta della FRIULAIR S.r.l.

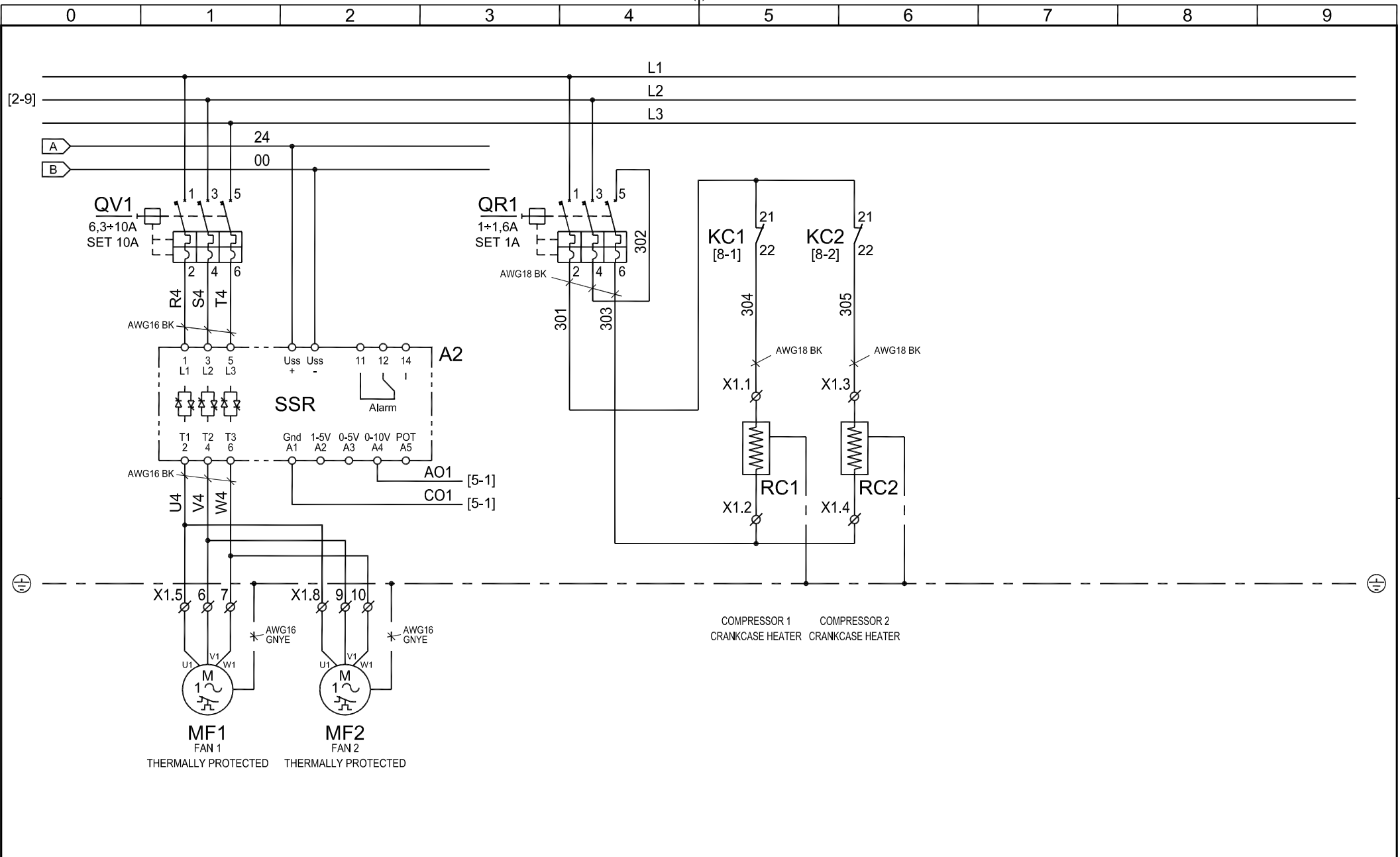

Unless specified AWG18 RD
 Technical modifications are subject to change without notice; errors not excluded



Titolo / Title : **SCHEMA ELETTRICO CWU065**
ELECTRICAL DIAGRAM CWU065
 FRIULAIR S.r.l. - 33050 CERVIGNANO DEL FRIULI (UD) - ITALY - Via Cisis, 36

Drawing no. : **FRCWU90CWU065Q0000** Rev. **00**
 Note :
 - Sheet **3** of **10**
 COMPUTER AIDED DESIGN

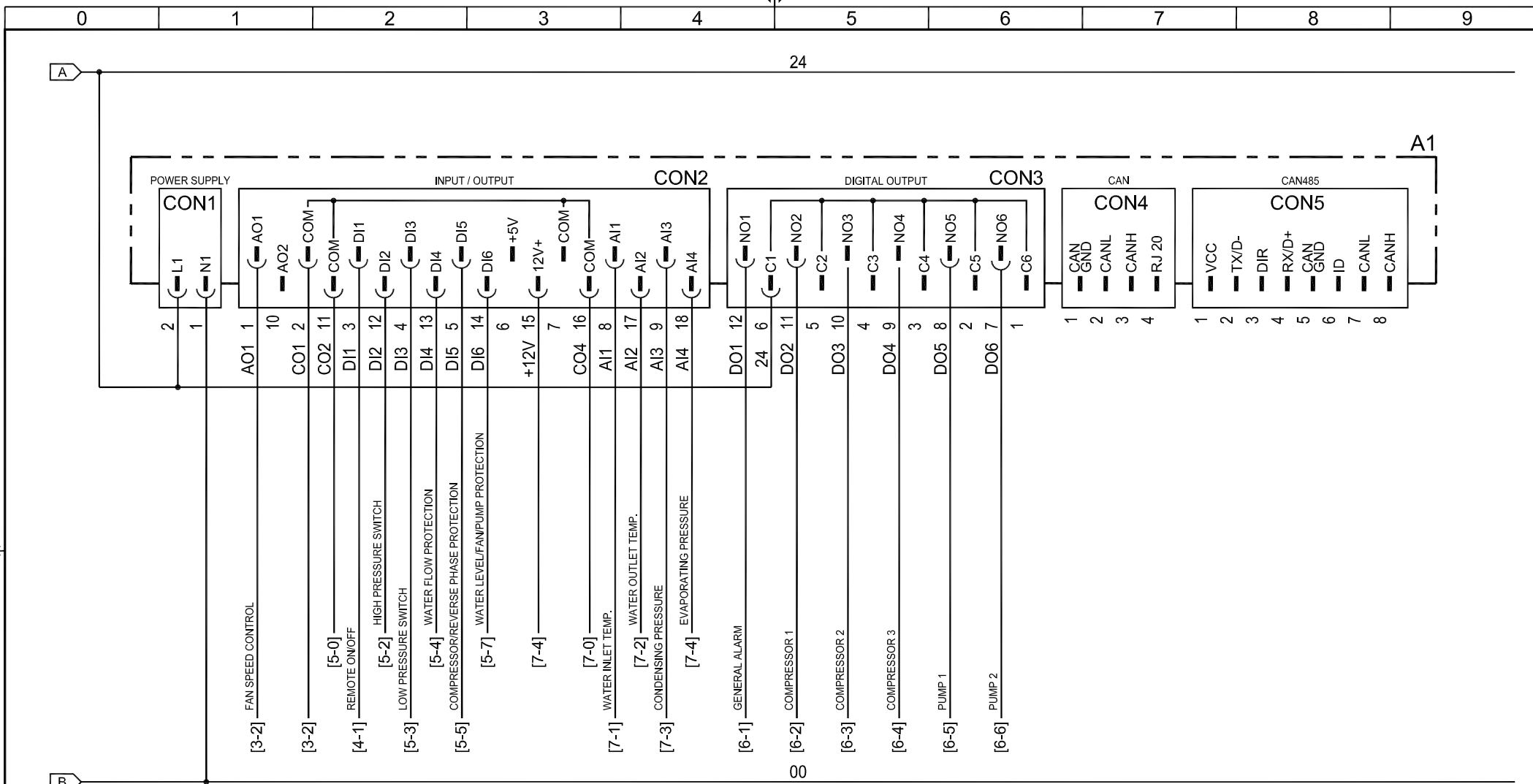

Technical modifications are subject to change without notice; errors not excluded



Titolo / Title :

SCHEMA ELETTRICO CWU065 ELECTRICAL DIAGRAM CWU065

FRIULAIR S.r.l. - 33050 CERVIGNANO DEL FRIULI (UD) - ITALY - Via Cisis, 36

Drawing no. : FRCWU90CWU065Q0000

Rev. 00

Note :

-

Sheet 4 of 10

This drawing cannot be reproduced, copied or given to third parties without FRIULAIR's written authorization

Questo disegno non può essere copiato, riprodotto né ceduto a terzi senza autorizzazione scritta della FRIULAIR S.r.l.

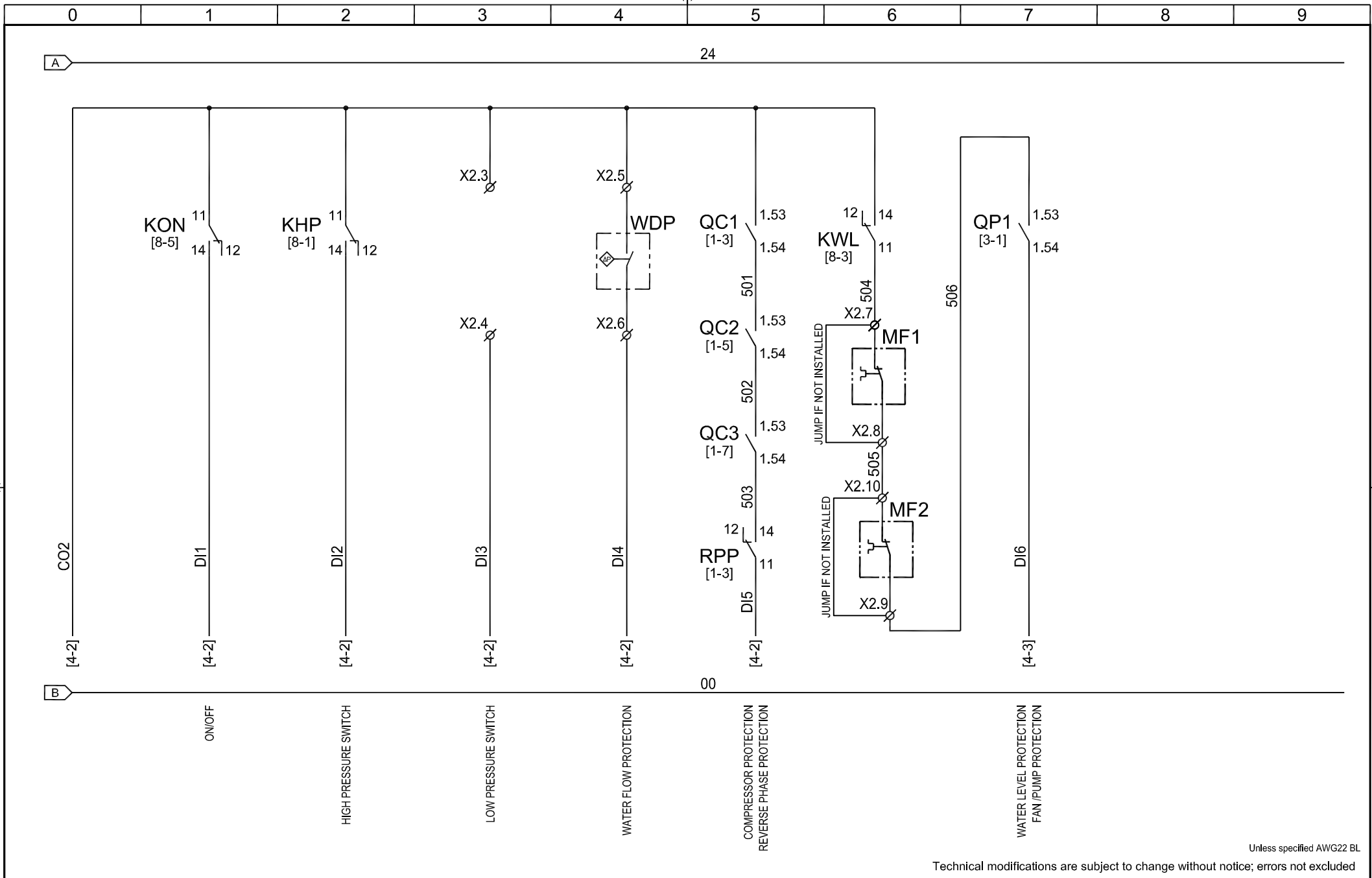

Unless specified AWG22 BL

Technical modifications are subject to change without notice; errors not excluded



Titolo / Title :

SCHEMA ELETTRICO CWU065 ELECTRICAL DIAGRAM CWU065

FRIULAIR S.r.l. - 33050 CERVIGNANO DEL FRIULI (UD) - ITALY - Via Cisis, 36

Drawing no. : FRCWU90CWU065Q0000

Rev. 00

Note :

-

Sheet 5 of 10

COMPUTER AIDED DESIGN

This drawing cannot be reproduced, copied or given to third parties without FRIULAIR's written authorization

Questo disegno non puo' essere copiato, riprodotto ne' ceduto a terzi senza autorizzazione scritta della FRIULAIR S.r.l.

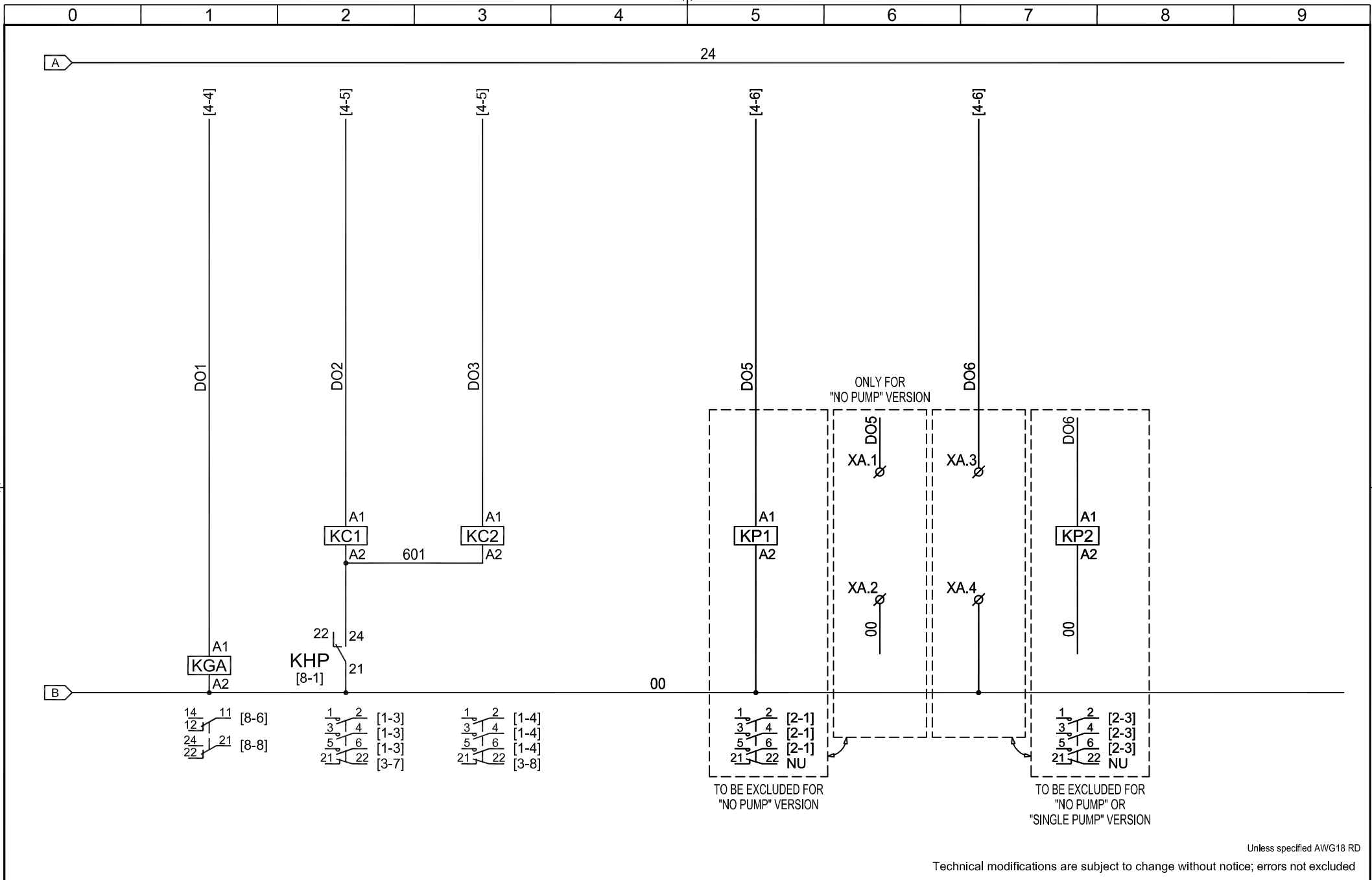

Unless specified AWG18 RD
 Technical modifications are subject to change without notice; errors not excluded

	Titolo / Title : SCHEMA ELETTRICO CWU065 ELECTRICAL DIAGRAM CWU065	Drawing no. : FRCWU90CWU065Q0000	Rev. 00
	FRIULAIR S.r.l. - 33050 CERVIGNANO DEL FRIULI (UD) - ITALY - Via Cisis, 36	Note : -	Sheet 6 of 10

This drawing cannot be reproduced, copied or given to third parties without FRIULAIR's written authorization

Questo disegno non può essere copiato, riprodotto né ceduto a terzi senza autorizzazione scritta della FRIULAIR S.r.l.

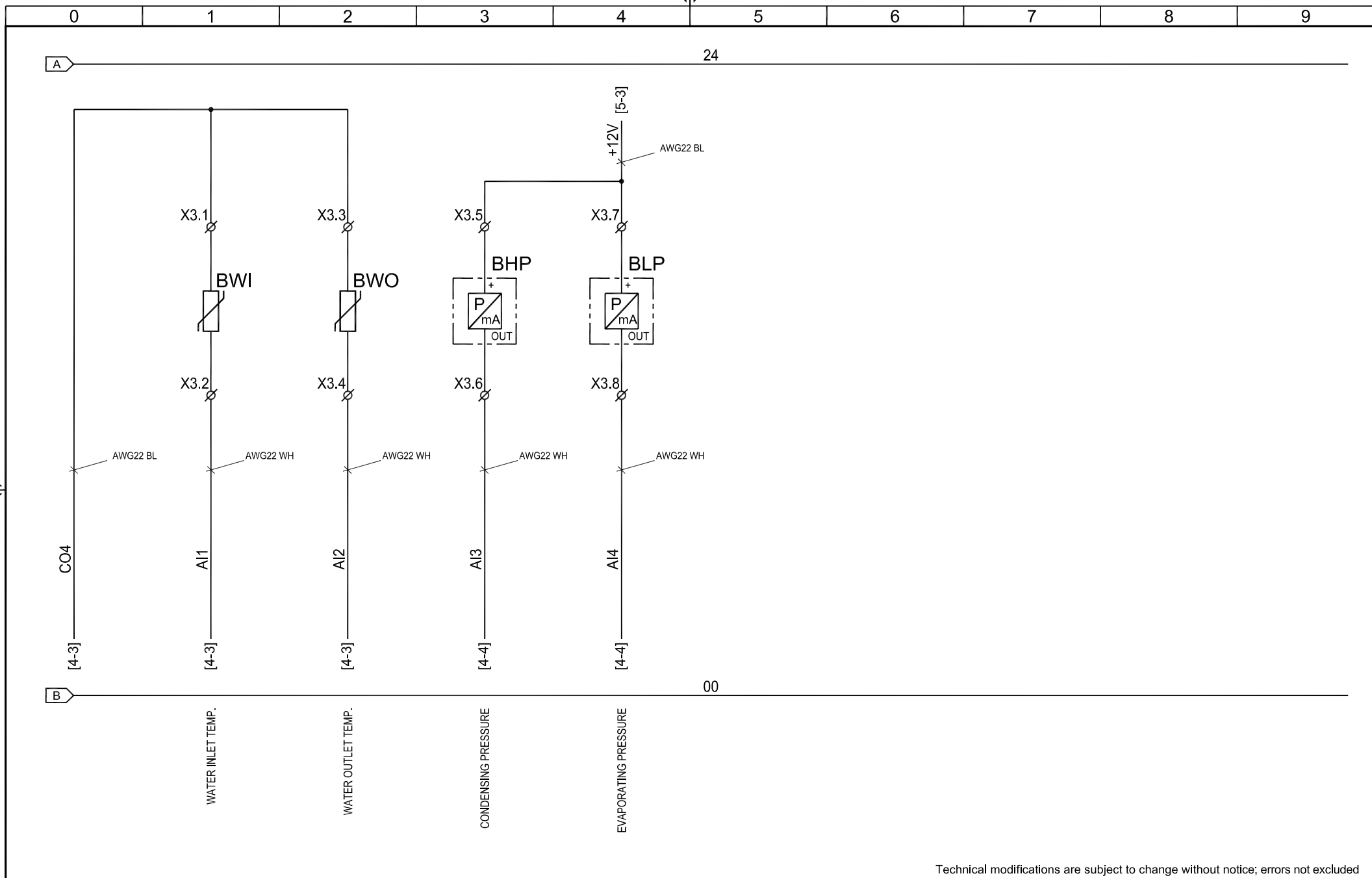

Technical modifications are subject to change without notice; errors not excluded



Titolo / Title : **SCHEMA ELETTRICO CWU065**
ELECTRICAL DIAGRAM CWU065
 FRIULAIR S.r.l. - 33050 CERVIGNANO DEL FRIULI (UD) - ITALY - Via Cisis, 36

Drawing no. : **FRCWU90CWU065Q0000** Rev. **00**
 Note :
 - Sheet **7** of **10**

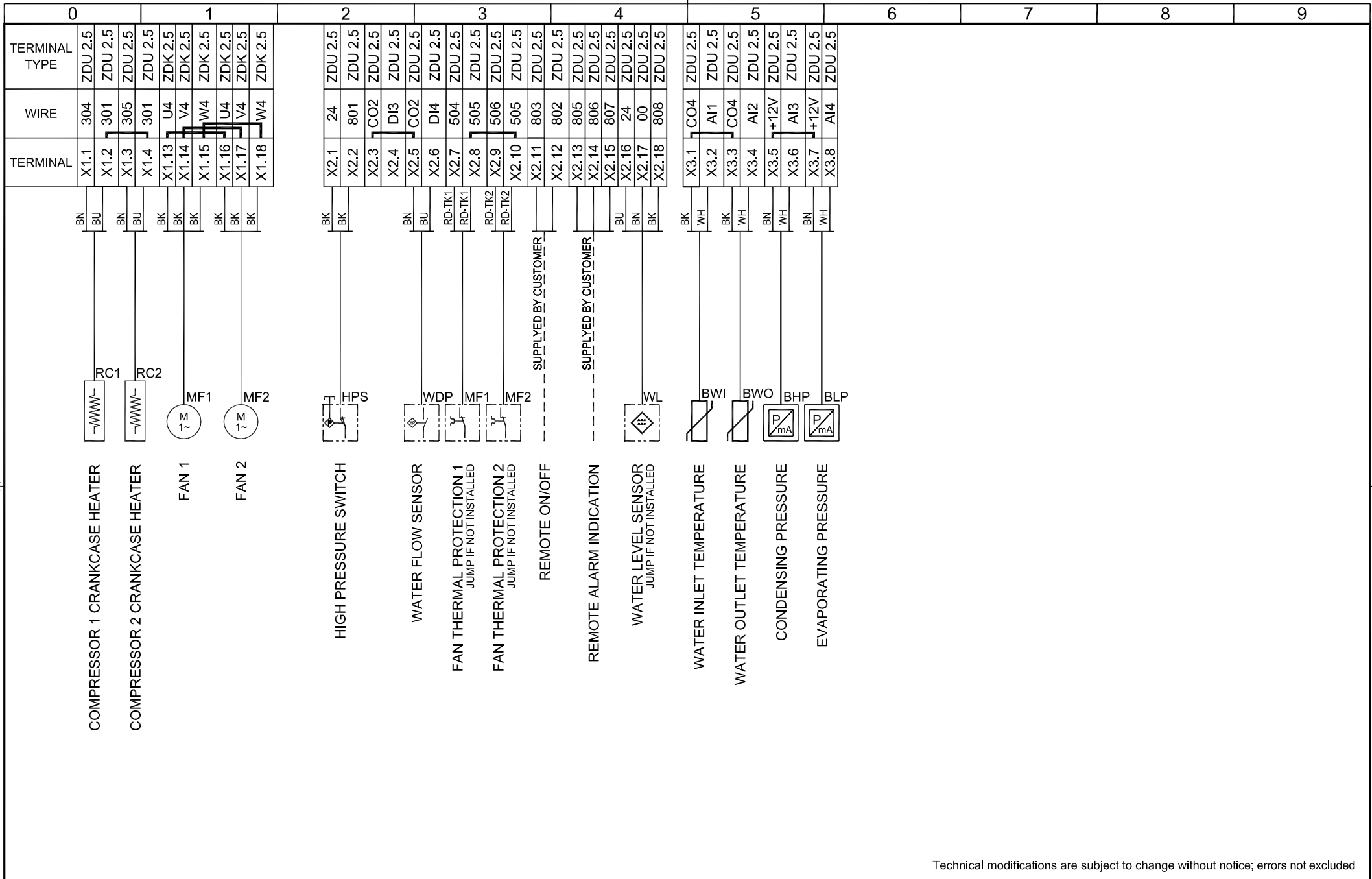

Technical modifications are subject to change without notice; errors not excluded



Titolo / Title :

**SCHEMA ELETTRICO CWU065
ELECTRICAL DIAGRAM CWU065**

FRIULAIR S.r.l. - 33050 CERVIGNANO DEL FRIULI (UD) - ITALY - Via Cisis, 36

Drawing no. : FRCWU90CWU065Q0000 Rev. 00

Note : -

This drawing cannot be reproduced, copied or given to third parties without FRIULAIR's written authorization

Questo disegno non può essere copiato, riprodotto né ceduto a terzi senza autorizzazione scritta della FRIULAIR S.r.l.

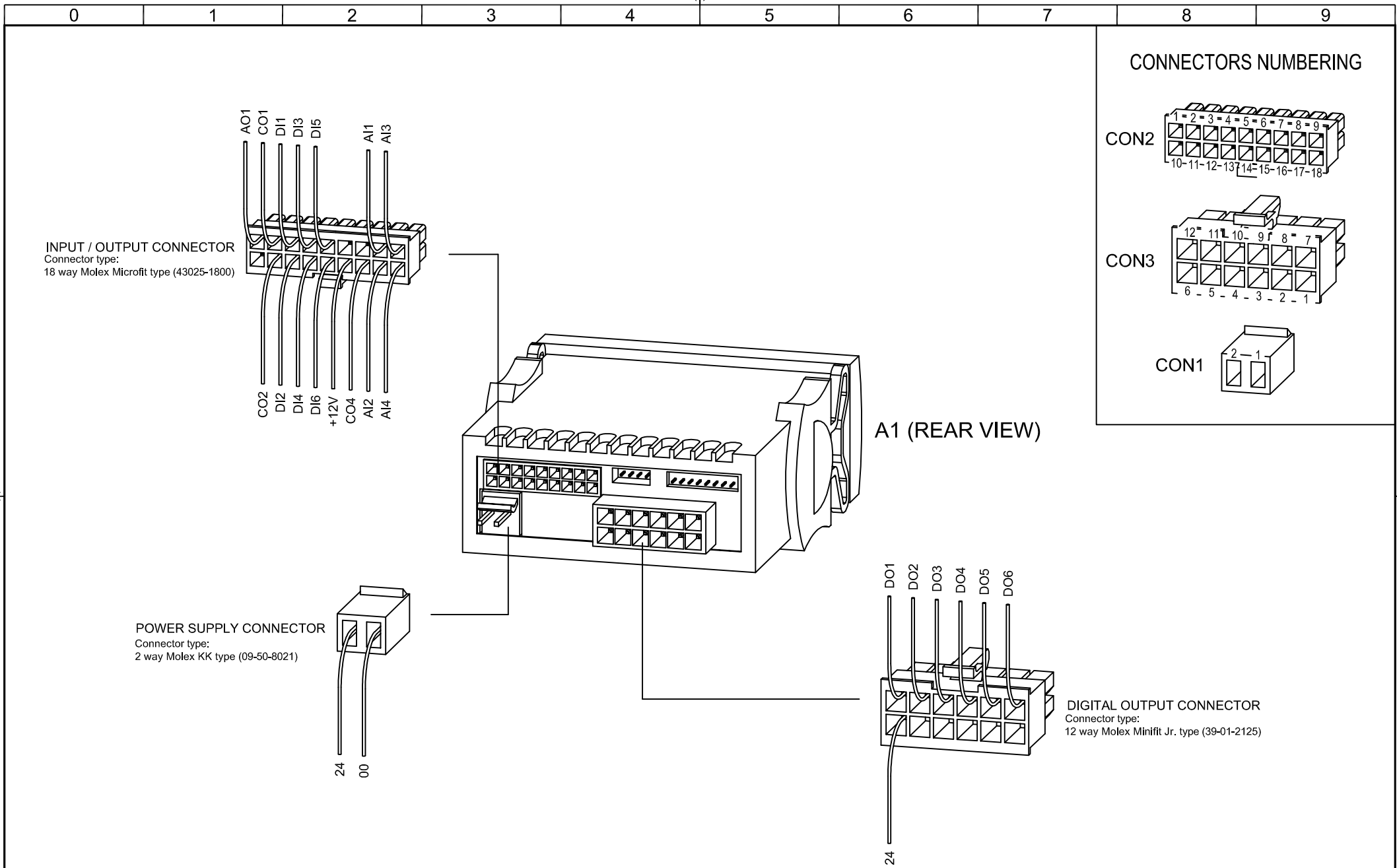

Technical modifications are subject to change without notice; errors not excluded



Titolo / Title : **SCHEMA ELETTRICO CWU065**
ELECTRICAL DIAGRAM CWU065

FRIULAIR S.r.l. - 33050 CERVIGNANO DEL FRIULI (UD) - ITALY - Via Cisis, 36

Drawing no. : **FRCWU90CWU065Q0000** Rev. **00**

Note : -

Sheet **10** of **10**

Titolo - Title

SCHEMA ELETTRICO CWU075÷090
ELECTRICAL DIAGRAM CWU075÷090

Disegno n° - Drawing nr.

FRCWU90CWU090Q0000

Revisione - Revision

01

This drawing cannot be reproduced, copied or given to third parties without FRIULAIR's written authorization

Questo disegno non può essere copiato, riprodotto né ceduto a terzi senza autorizzazione scritta della FRIULAIR S.r.l.

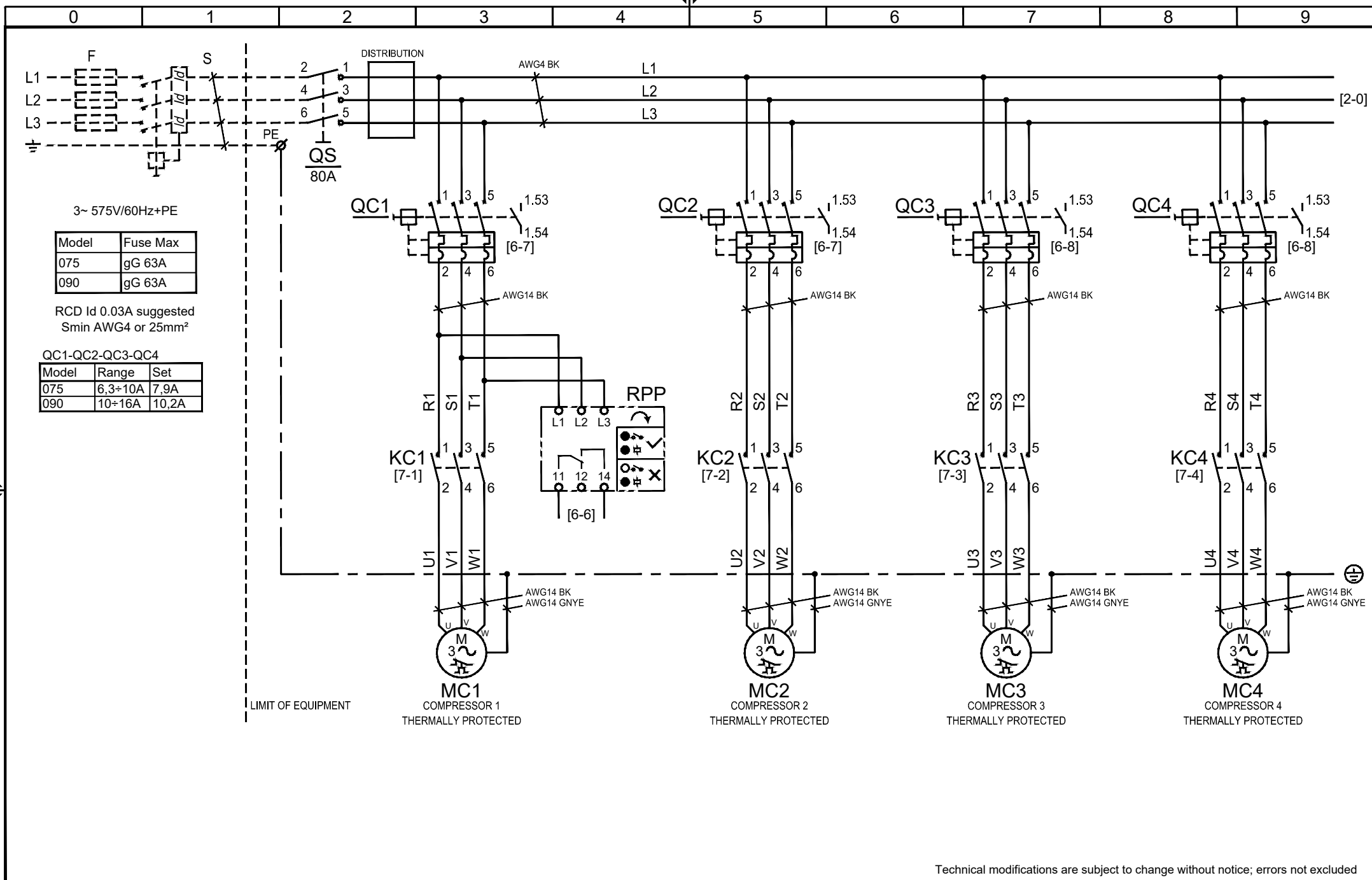

3~ 575V/60Hz+PE

Model	Fuse Max
075	gG 63A
090	gG 63A

RCD Id 0.03A suggested
Smin AWG4 or 25mm²

QC1-QC2-QC3-QC4

Model	Range	Set
075	6,3÷10A	7,9A
090	10÷16A	10,2A

Technical modifications are subject to change without notice; errors not excluded



Titolo / Title : **SCHEMA ELETTRICO CWU075÷090**
ELECTRICAL DIAGRAM CWU075÷090
 FRIULAIR S.r.l. - 33050 CERVIGNANO DEL FRIULI (UD) - ITALY - Via Cisis, 36

Drawing no. : **FRCWU90CWU090Q0000** Rev. **01**
 Note :
 Sheet **1** of **11**
 COMPUTER AIDED DESIGN

This drawing cannot be reproduced, copied or given to third parties without FRIULAIR's written authorization

Questo disegno non può essere copiato, riprodotto né ceduto a terzi senza autorizzazione scritta della FRIULAIR S.r.l.

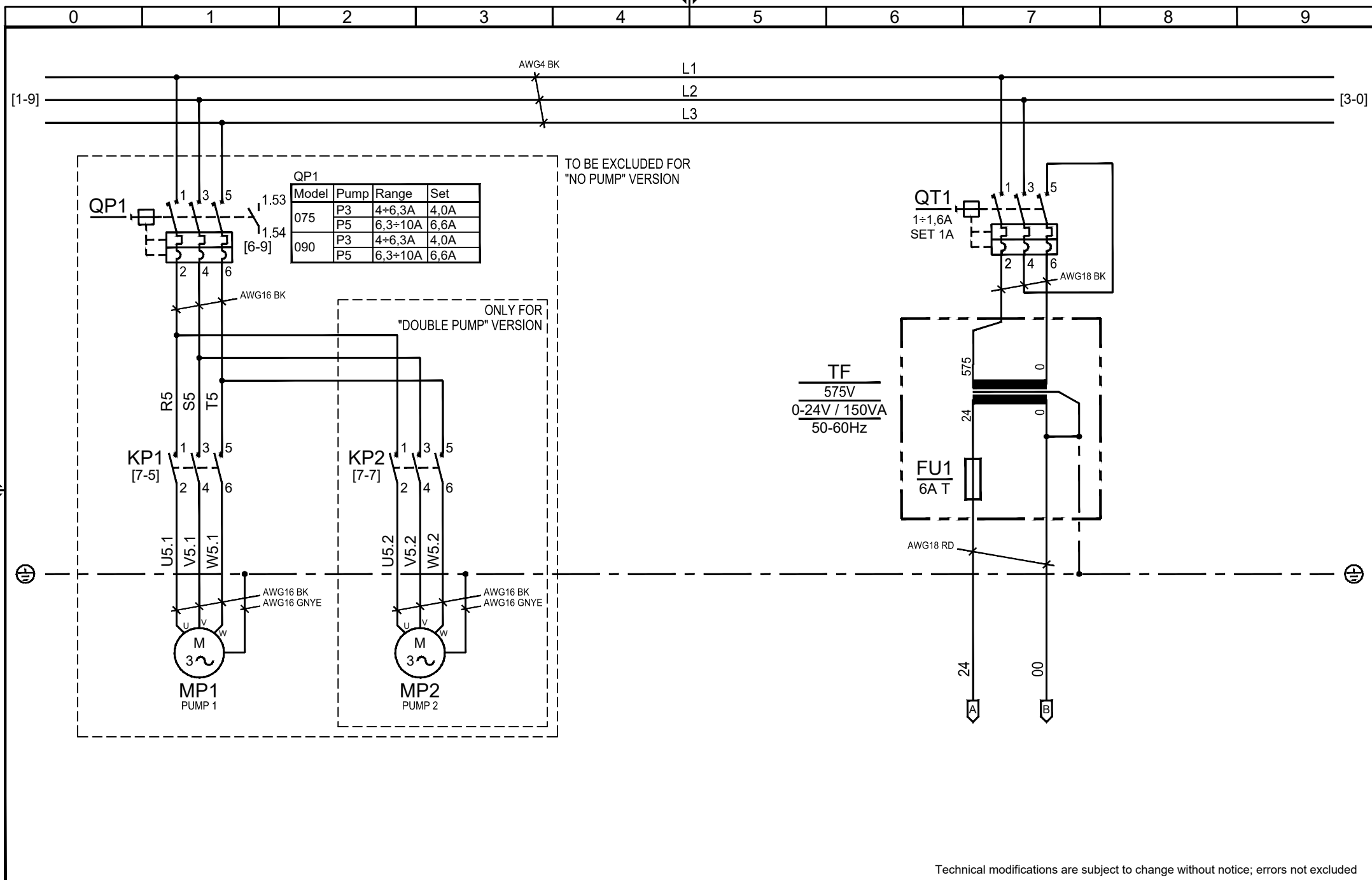

Technical modifications are subject to change without notice; errors not excluded



Titolo / Title : **SCHEMA ELETTRICO CWU075÷090**
ELECTRICAL DIAGRAM CWU075÷090
 FRIULAIR S.r.l. - 33050 CERVIGNANO DEL FRIULI (UD) - ITALY - Via Cisis, 36

Drawing no. : **FRCWU90CWU090Q0000** Rev. **01**
 Note :
 - Sheet **2** of **11**
 COMPUTER AIDED DESIGN

This drawing cannot be reproduced, copied or given to third parties without FRIULAIR's written authorization

Questo disegno non può essere copiato, riprodotto né ceduto a terzi senza autorizzazione scritta della FRIULAIR S.r.l.

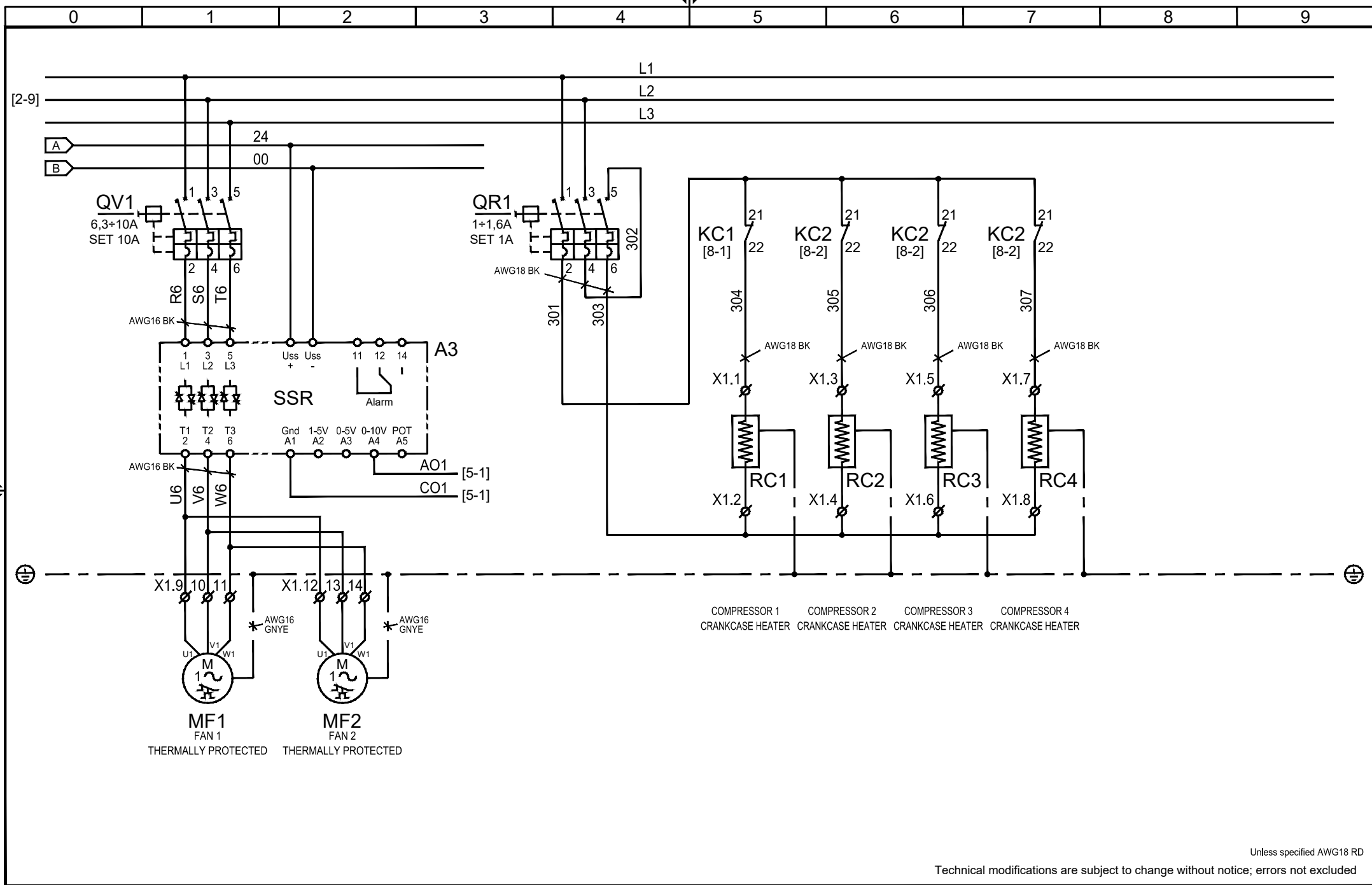

COMPRESSOR 1 CRANKCASE HEATER COMPRESSOR 2 CRANKCASE HEATER COMPRESSOR 3 CRANKCASE HEATER COMPRESSOR 4 CRANKCASE HEATER

Unless specified AWG18 RD
 Technical modifications are subject to change without notice; errors not excluded



Titolo / Title : **SCHEMA ELETTRICO CWU075÷090**
ELECTRICAL DIAGRAM CWU075÷090
 FRIULAIR S.r.l. - 33050 CERVIGNANO DEL FRIULI (UD) - ITALY - Via Cisis, 36

Drawing no. : **FRCWU90CWU090Q0000** Rev. **01**
 Note :
 -

This drawing cannot be reproduced, copied or given to third parties without FRIULAIR's written authorization

Questo disegno non può essere copiato, riprodotto né ceduto a terzi senza autorizzazione scritta della FRIULAIR S.r.l.

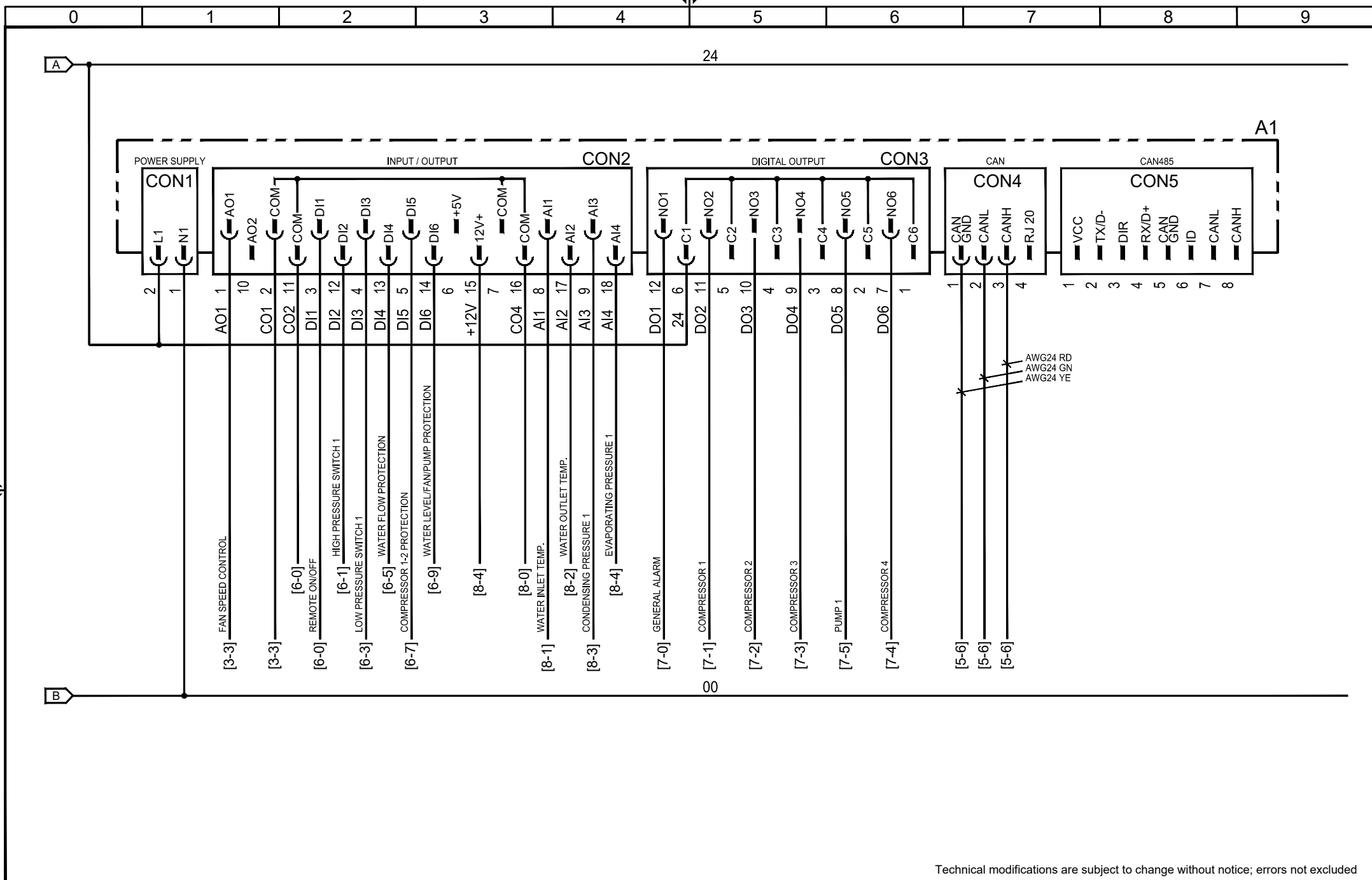

Technical modifications are subject to change without notice; errors not excluded



Titolo / Title :

SCHEMA ELETTRICO CWU075÷090
ELECTRICAL DIAGRAM CWU075÷090

FRIULAIR S.r.l. - 33050 CERVIGNANO DEL FRIULI (UD) - ITALY - Via Cisis, 36

Drawing no. : FRCWU90CWU090Q0000 Rev. 01

Note :

Sheet 4 of 11

This drawing cannot be reproduced, copied or given to third parties without FRIULAIR's written authorization

Questo disegno non può essere copiato, riprodotto né ceduto a terzi senza autorizzazione scritta della FRIULAIR S.r.l.

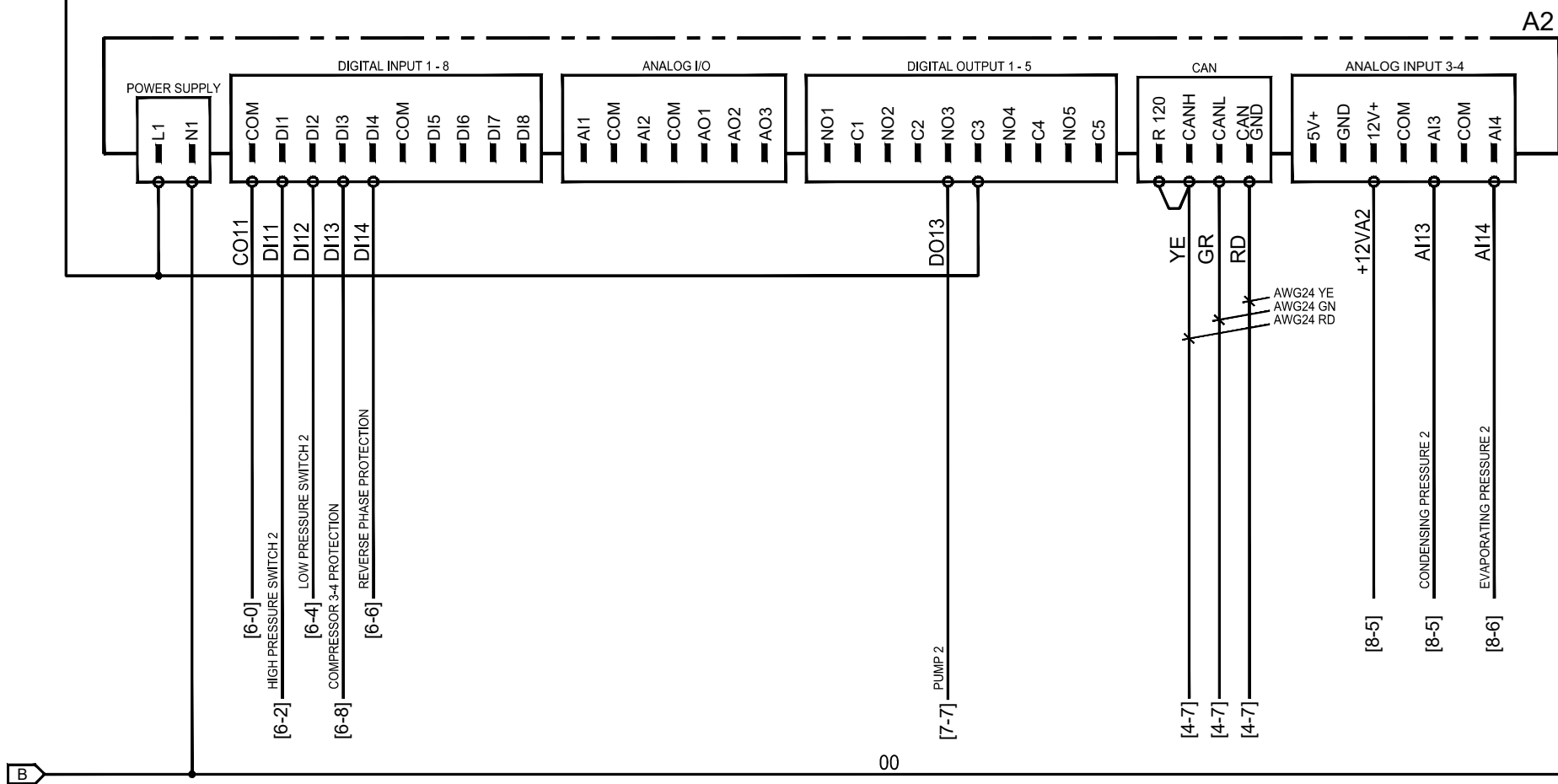

Technical modifications are subject to change without notice; errors not excluded



Titolo / Title :

SCHEMA ELETTRICO CWU075÷090
ELECTRICAL DIAGRAM CWU075÷090

FRIULAIR S.r.l. - 33050 CERVIGNANO DEL FRIULI (UD) - ITALY - Via Cisis, 36

Drawing no. : Rev.

FRCWU90CWU090Q0000 01

Note :

- Sheet 5 of 11

This drawing cannot be reproduced, copied or given to third parties without FRIULAIR's written authorization

Questo disegno non può essere copiato, riprodotto né ceduto a terzi senza autorizzazione scritta della FRIULAIR S.r.l.

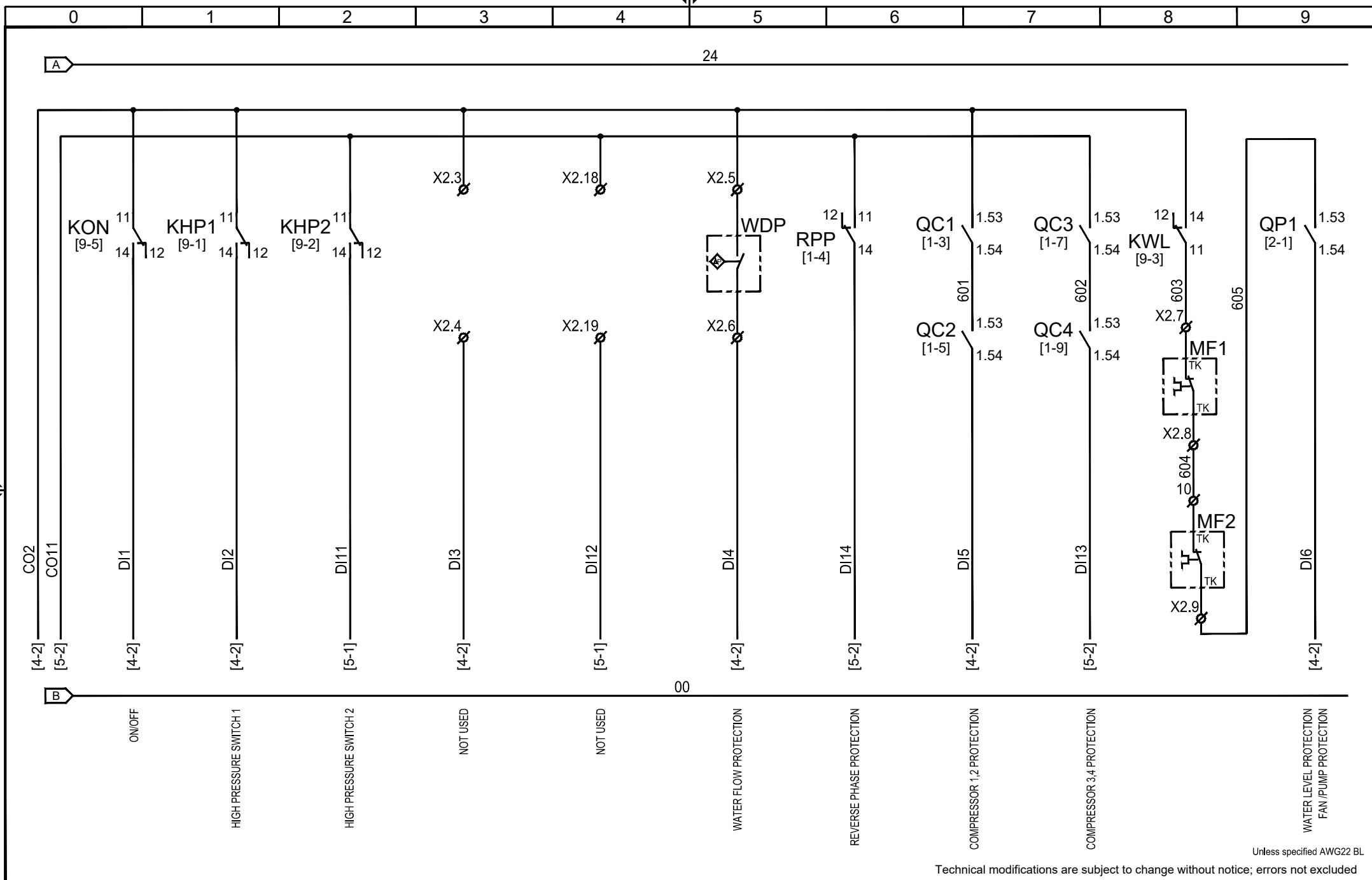

Unless specified AWG22 BL
 Technical modifications are subject to change without notice; errors not excluded



Titolo / Title : **SCHEMA ELETTRICO CWU075÷090**
ELECTRICAL DIAGRAM CWU075÷090
 FRIULAIR S.r.l. - 33050 CERVIGNANO DEL FRIULI (UD) - ITALY - Via Cisis, 36

Drawing no. : **FRCWU90CWU090Q0000** Rev. **01**
 Note :
 -
 Sheet **6** of **11**
 COMPUTER AIDED DESIGN

This drawing cannot be reproduced, copied or given to third parties without FRIULAIR's written authorization

Questo disegno non può essere copiato, riprodotto né ceduto a terzi senza autorizzazione scritta della FRIULAIR S.r.l.

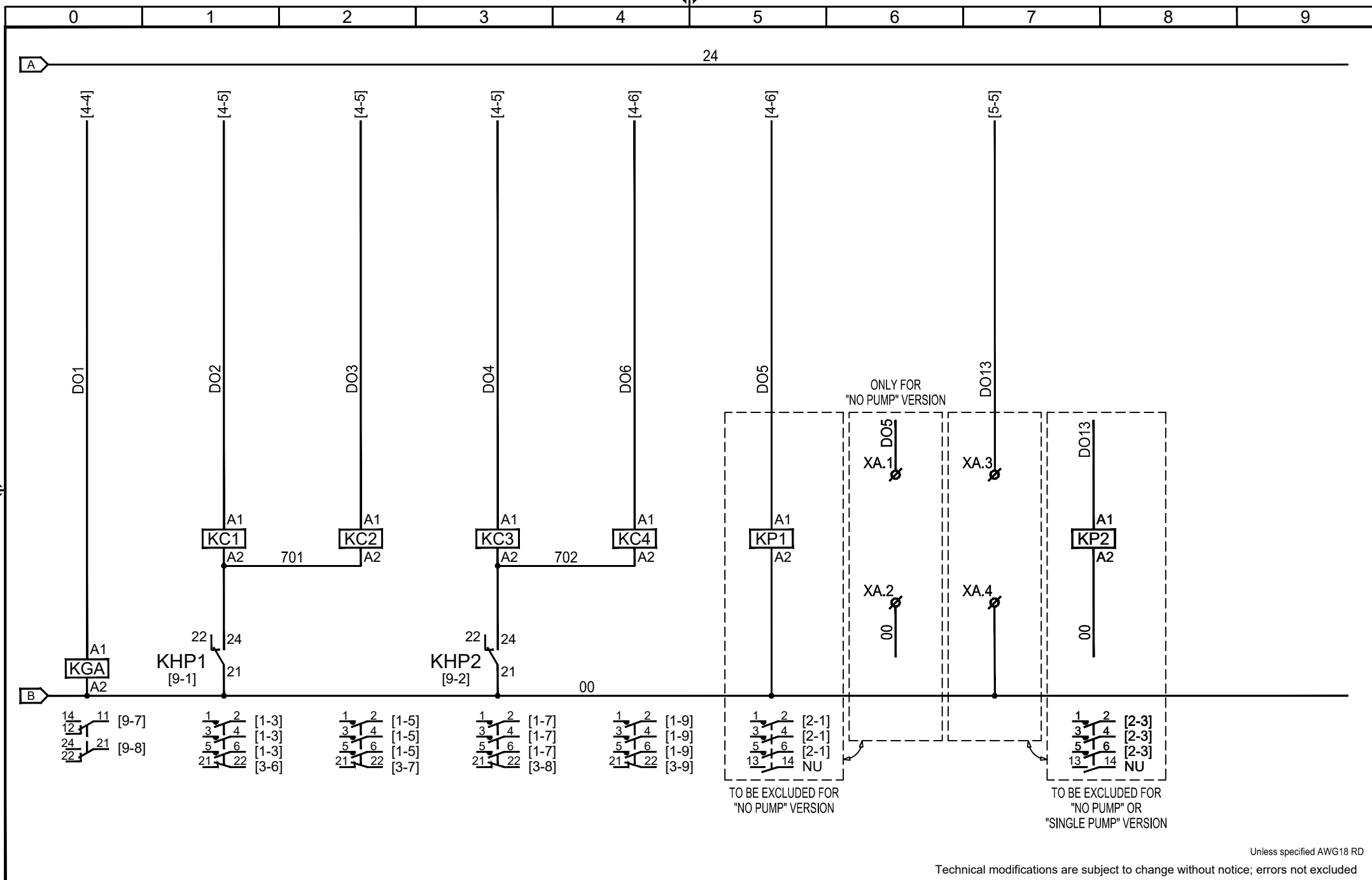

Unless specified AWG18 RD
Technical modifications are subject to change without notice; errors not excluded



Titolo / Title : **SCHEMA ELETTRICO CWU075÷090**
ELECTRICAL DIAGRAM CWU075÷090

FRIULAIR S.r.l. - 33050 CERVIGNANO DEL FRIULI (UD) - ITALY - Via Cisis, 36

Drawing no. : **FRCWU90CWU090Q0000** Rev. **01**

Note : -

Sheet **7** of **11**

COMPUTER AIDED DESIGN

This drawing cannot be reproduced, copied or given to third parties without FRIULAIR's written authorization

Questo disegno non può essere copiato, riprodotto né ceduto a terzi senza autorizzazione scritta della FRIULAIR S.r.l.

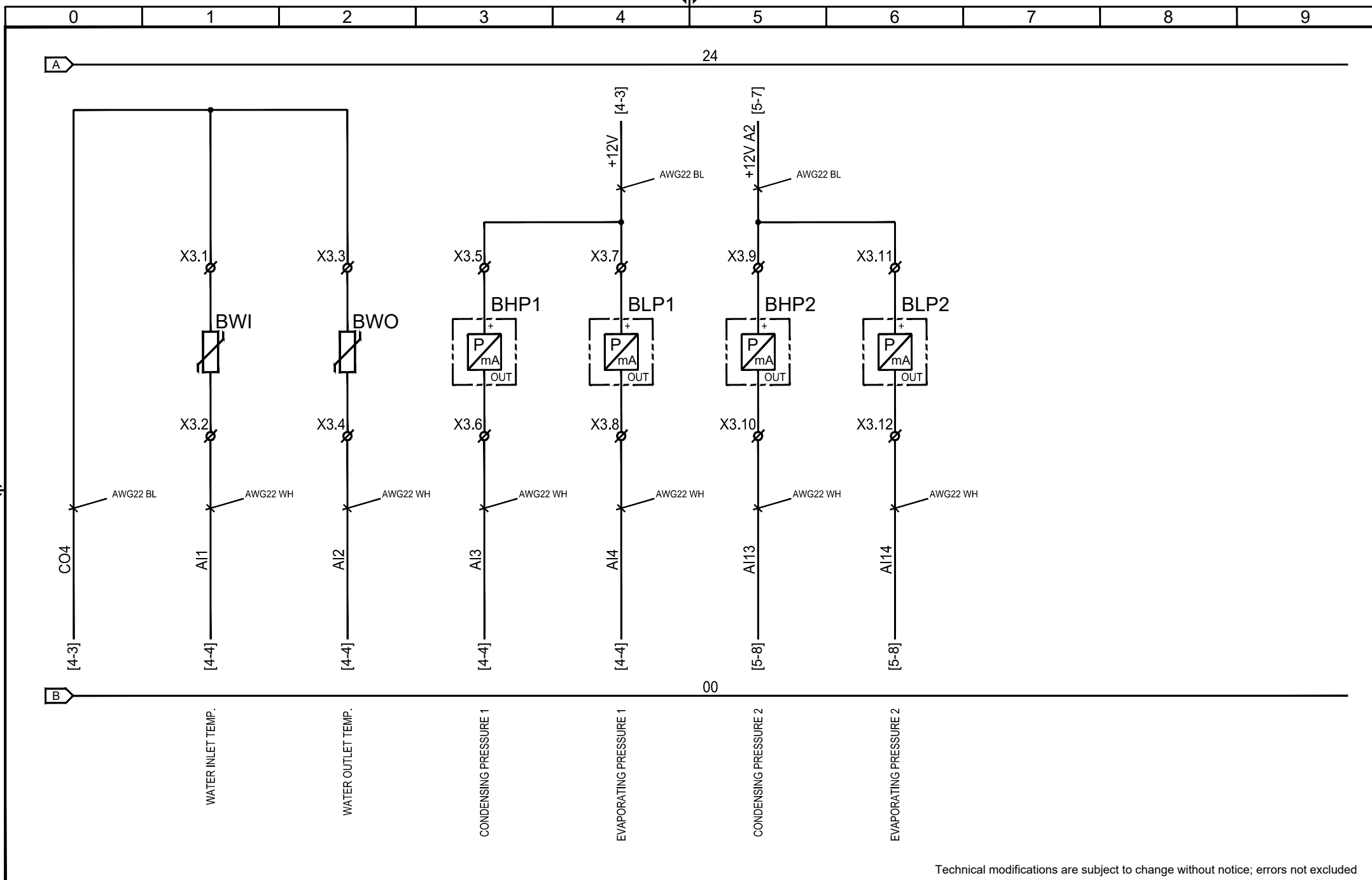

Technical modifications are subject to change without notice; errors not excluded



Titolo / Title :

SCHEMA ELETTRICO CWU075÷090 ELECTRICAL DIAGRAM CWU075÷090

Drawing no. : FRCWU90CWU090Q0000 Rev. 01

Note : -

FRIULAIR S.r.l. - 33050 CERVIGNANO DEL FRIULI (UD) - ITALY - Via Cisis, 36

Sheet 8 of 11

COMPUTER AIDED DESIGN

This drawing cannot be reproduced, copied or given to third parties without FRIULAIR's written authorization

Questo disegno non può essere copiato, riprodotto né ceduto a terzi senza autorizzazione scritta della FRIULAIR S.r.l.

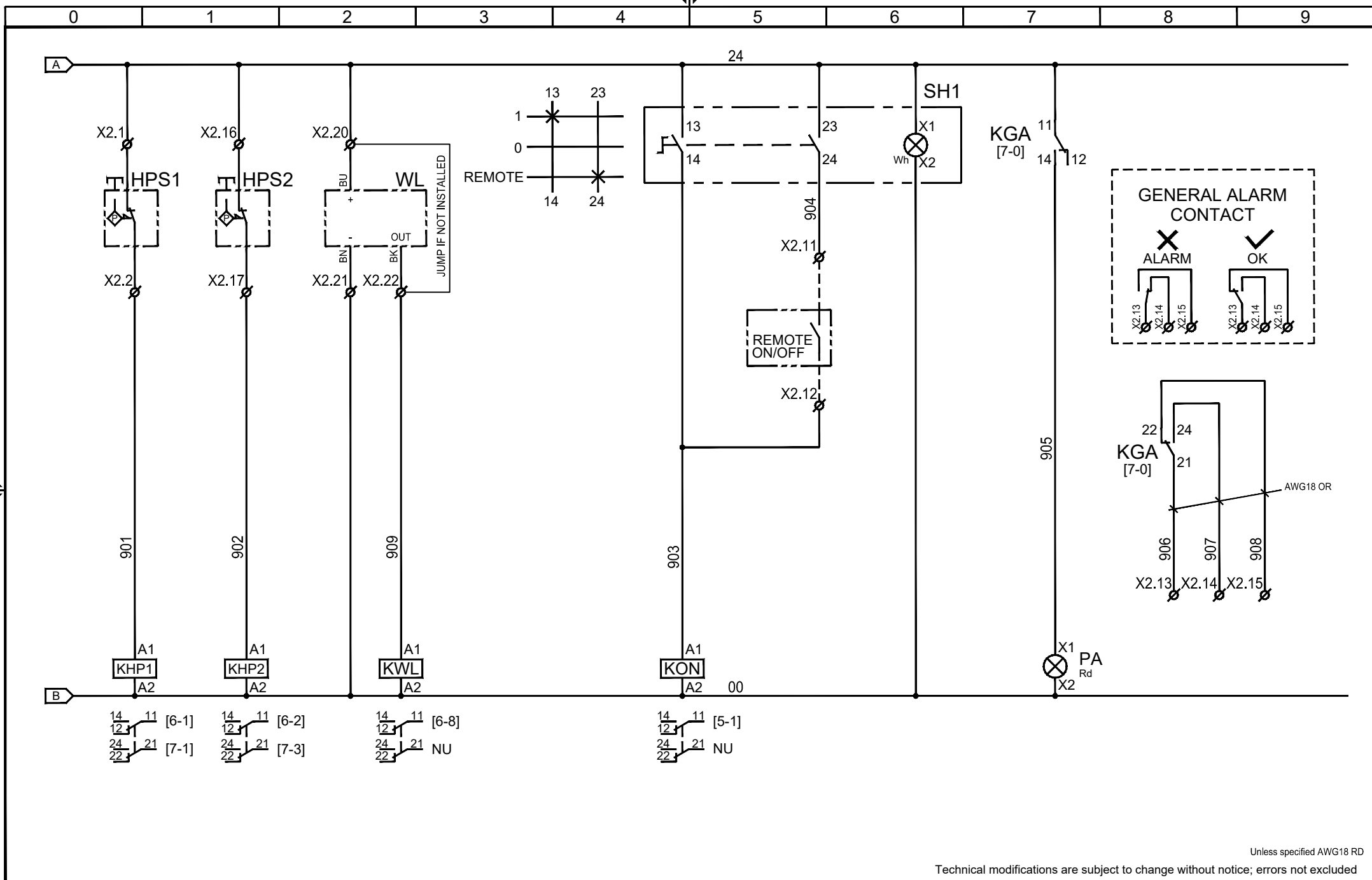

Unless specified AWG18 RD
 Technical modifications are subject to change without notice; errors not excluded



Titolo / Title : **SCHEMA ELETTRICO CWU075÷090**
ELECTRICAL DIAGRAM CWU075÷090
 FRIULAIR S.r.l. - 33050 CERVIGNANO DEL FRIULI (UD) - ITALY - Via Cisis, 36

Drawing no. : **FRCWU90CWU090Q0000** Rev. **01**
 Note :
 -
 Sheet **9** of **11**
 COMPUTER AIDED DESIGN

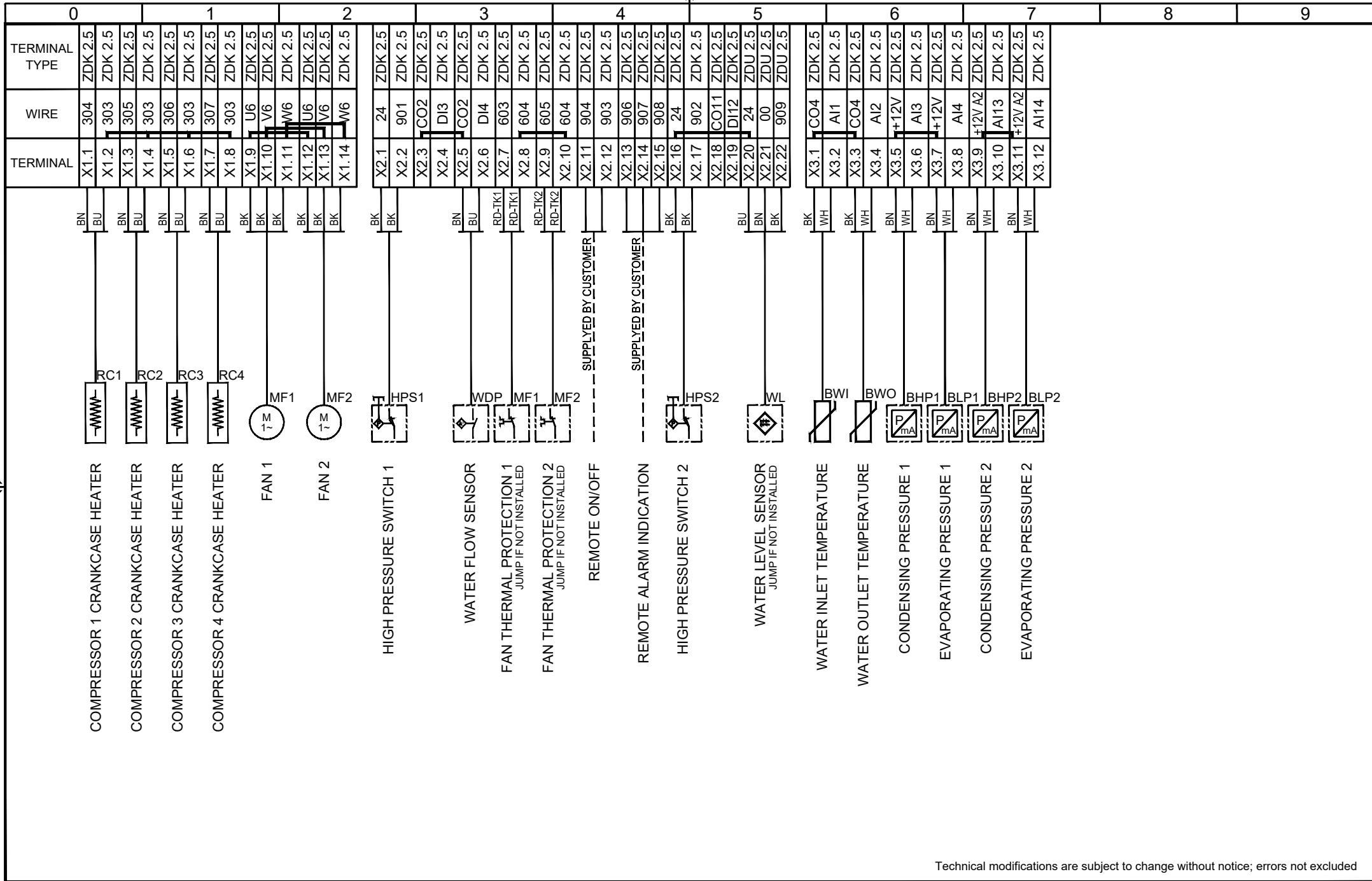

Technical modifications are subject to change without notice; errors not excluded



Titolo / Title :

SCHEMA ELETTRICO CWU075÷090
ELECTRICAL DIAGRAM CWU075÷090

FRIULAIR S.r.l. - 33050 CERVIGNANO DEL FRIULI (UD) - ITALY - Via Cisis, 36

Drawing no. :

FRCWU90CWU090Q0000 01

Note :

-

This drawing cannot be reproduced, copied or given to third parties without FRIULAIR's written authorization

Questo disegno non può essere copiato, riprodotto né ceduto a terzi senza autorizzazione scritta della FRIULAIR S.r.l.

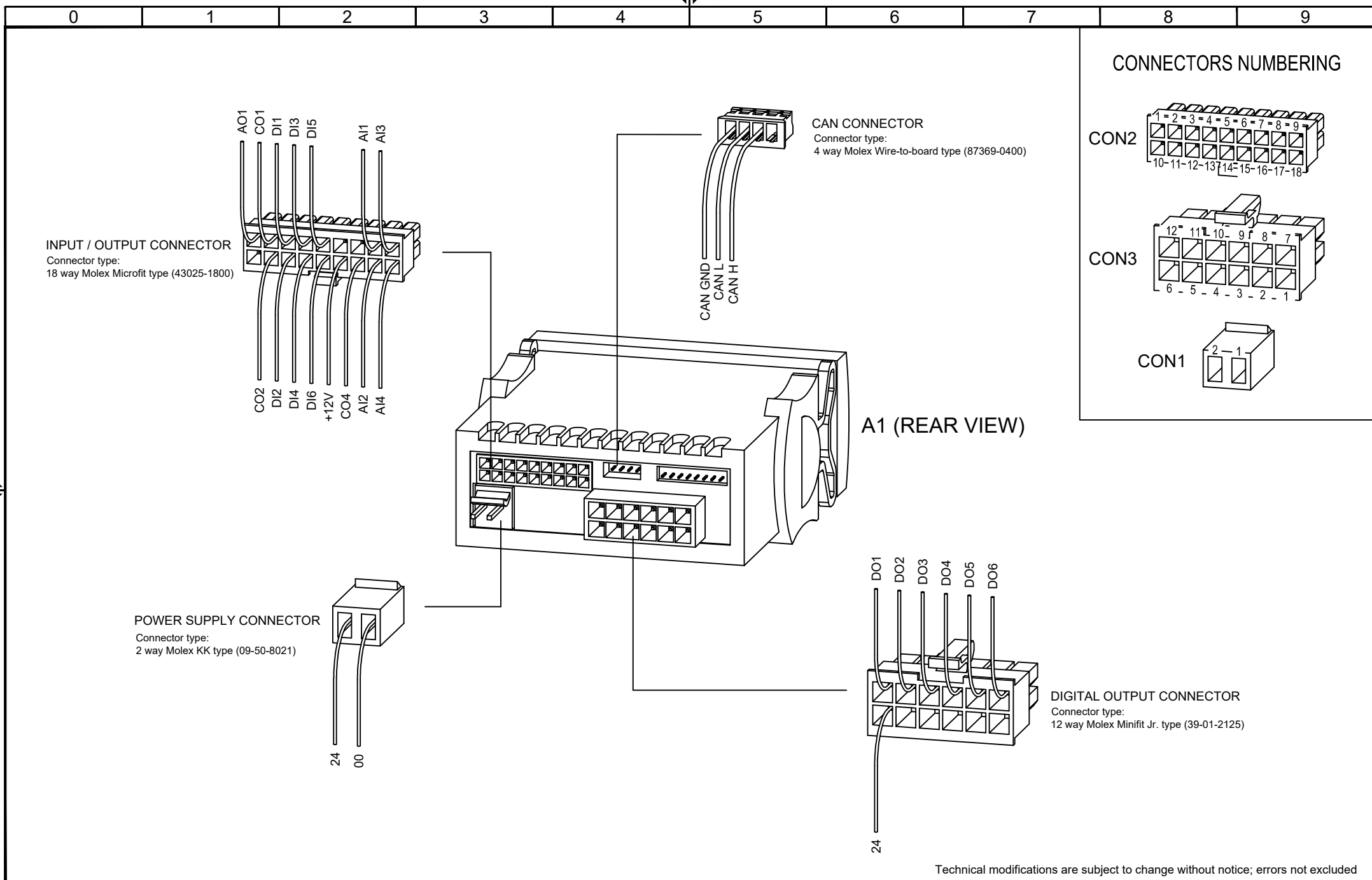

Technical modifications are subject to change without notice; errors not excluded



Titolo / Title : **SCHEMA ELETTRICO CWU075÷090**
ELECTRICAL DIAGRAM CWU075÷090
 FRIULAIR S.r.l. - 33050 CERVIGNANO DEL FRIULI (UD) - ITALY - Via Cisis, 36

Drawing no. : **FRCWU90CWU090Q000** Rev. **01**
 Note :
 - Sheet **11** of **11**
 COMPUTER AIDED DESIGN

Titolo - Title

SCHEMA ELETTRICO CWU130-150 ELECTRICAL DIAGRAM CWU130-150

Disegno n° - Drawing nr.

FRCWU90CWU130Q0000

Revisione - Revision

01

This drawing cannot be reproduced, copied or given to third parties without FRIULAIR's written authorization

Questo disegno non può essere copiato, riprodotto né ceduto a terzi senza autorizzazione scritta della FRIULAIR S.r.l.

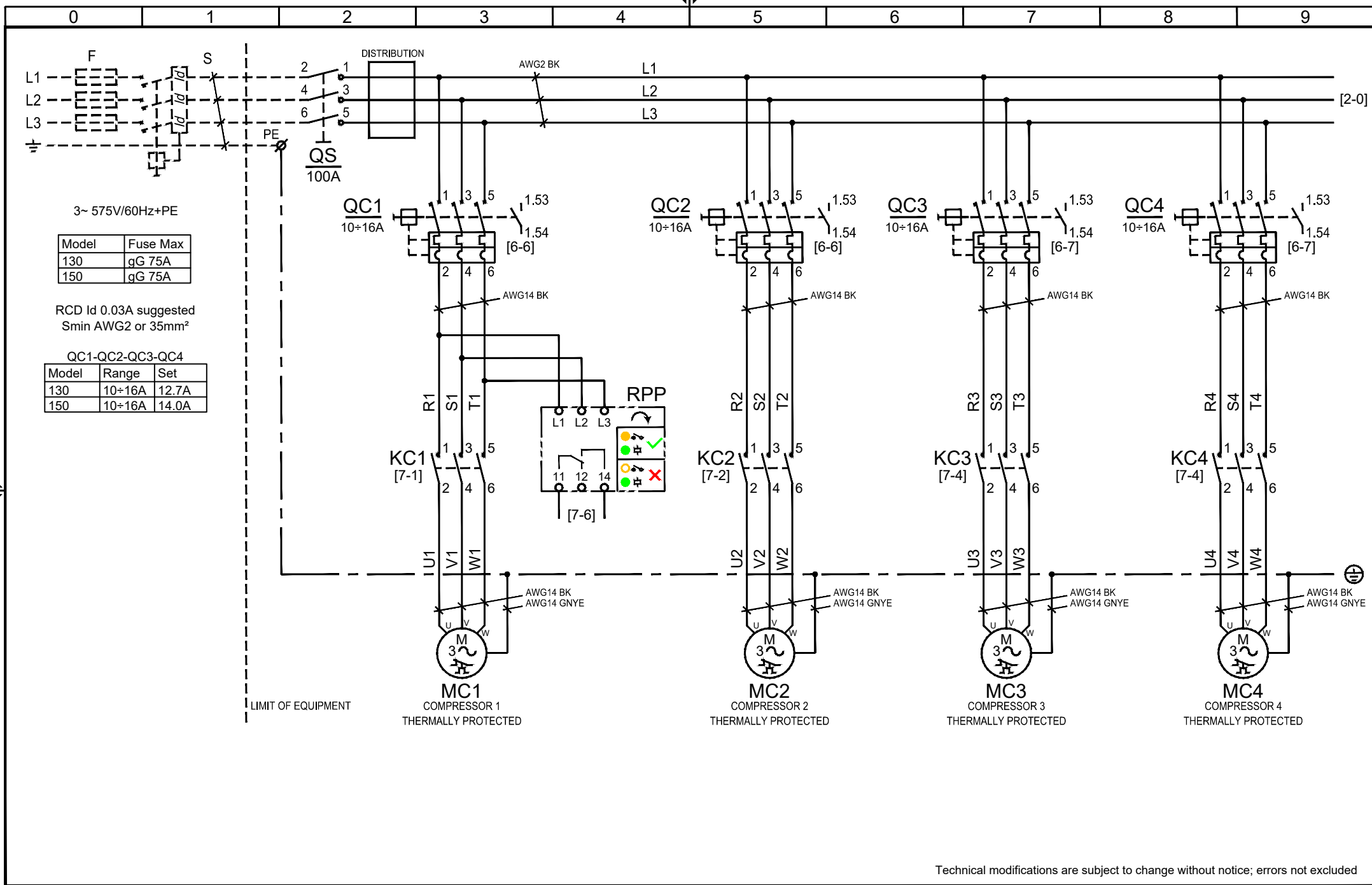

3~ 575V/60Hz+PE

Model	Fuse Max
130	gG 75A
150	gG 75A

RCD Id 0.03A suggested
Smin AWG2 or 35mm²

QC1-QC2-QC3-QC4

Model	Range	Set
130	10÷16A	12.7A
150	10÷16A	14.0A

Technical modifications are subject to change without notice; errors not excluded



Titolo / Title : **SCHEMA ELETTRICO CWU130-150**
ELECTRICAL DIAGRAM CWU130-150
 FRIULAIR S.r.l. - 33050 CERVIGNANO DEL FRIULI (UD) - ITALY - Via Cisis, 36

Drawing no. : **FRCWU90CWU130Q000** Rev. **01**
 Note :
 Sheet **1** of **11**
 COMPUTER AIDED DESIGN

This drawing cannot be reproduced, copied or given to third parties without FRIULAIR's written authorization

Questo disegno non può essere copiato, riprodotto né ceduto a terzi senza autorizzazione scritta della FRIULAIR S.r.l.

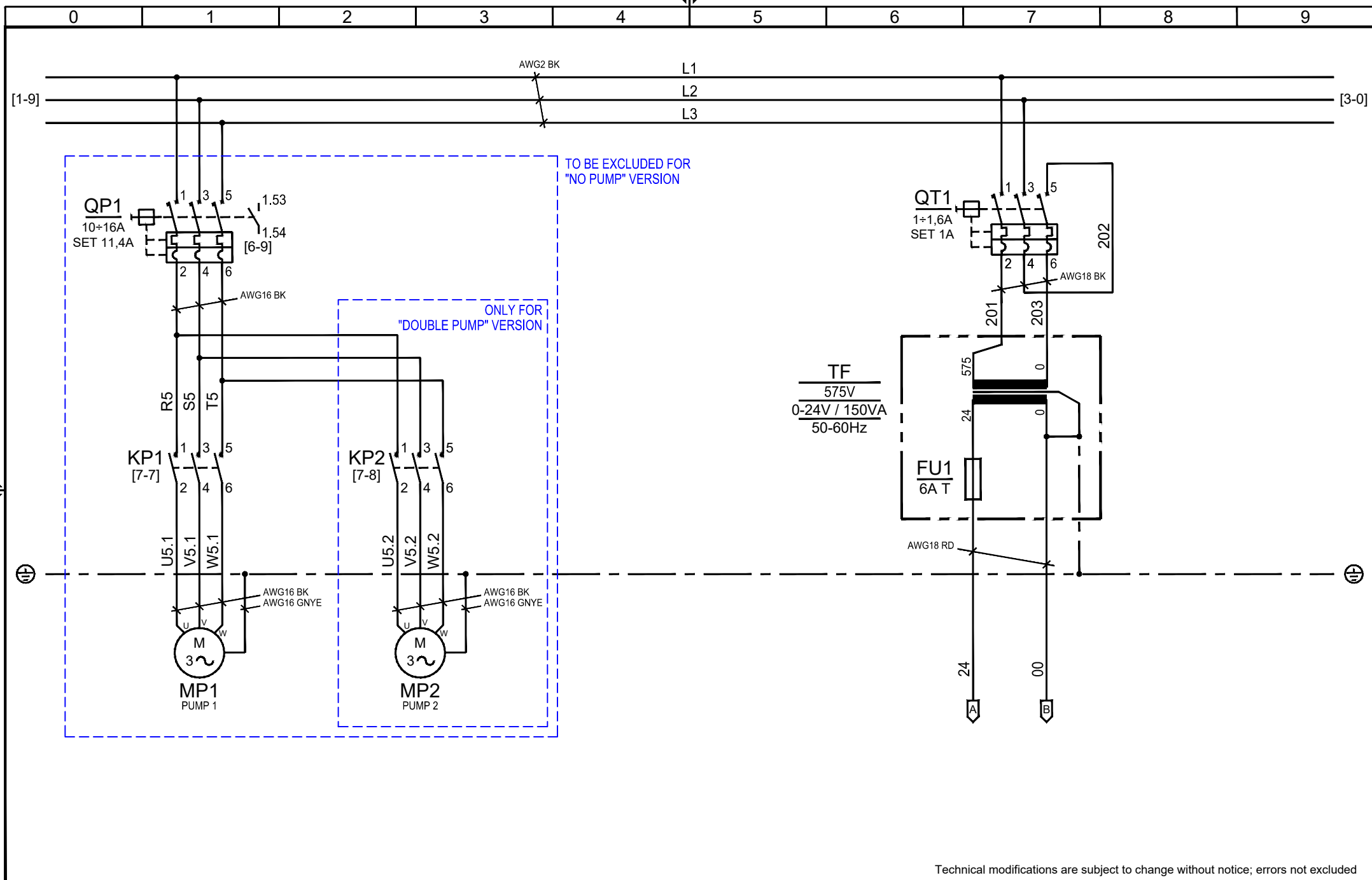

Technical modifications are subject to change without notice; errors not excluded



Titolo / Title : **SCHEMA ELETTRICO CWU130-150**
ELECTRICAL DIAGRAM CWU130-150
 FRIULAIR S.r.l. - 33050 CERVIGNANO DEL FRIULI (UD) - ITALY - Via Cisis, 36

Drawing no. : **FRCWU90CWU130Q000** Rev. **01**
 Note :
 -

This drawing cannot be reproduced, copied or given to third parties without FRIULAIR's written authorization

Questo disegno non può essere copiato, riprodotto né ceduto a terzi senza autorizzazione scritta della FRIULAIR S.r.l.

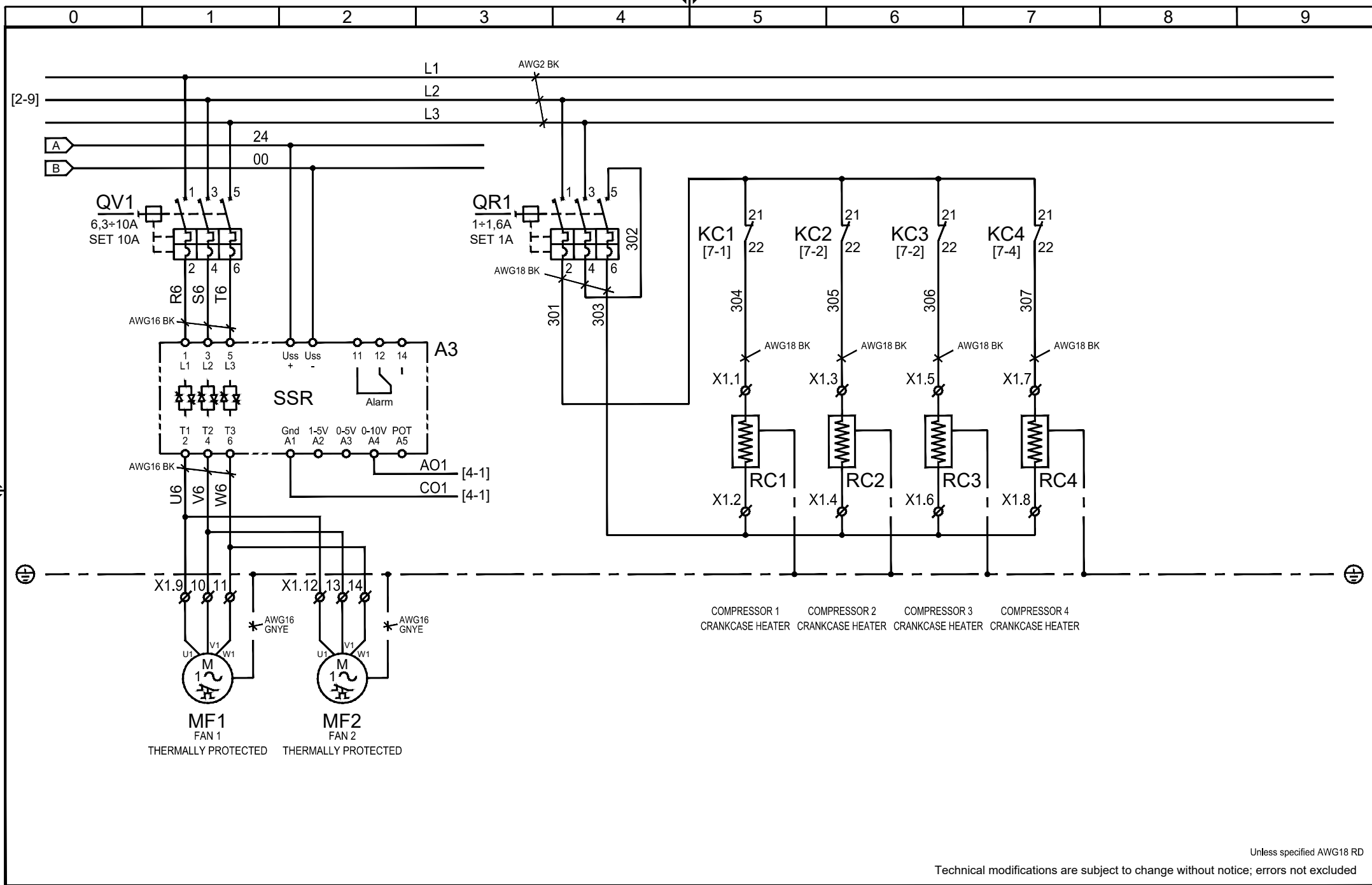

Unless specified AWG18 RD
 Technical modifications are subject to change without notice; errors not excluded



Titolo / Title : **SCHEMA ELETTRICO CWU130-150**
ELECTRICAL DIAGRAM CWU130-150

FRIULAIR S.r.l. - 33050 CERVIGNANO DEL FRIULI (UD) - ITALY - Via Cisis, 36

Drawing no. : **FRCWU90CWU130Q000** Rev. **01**
 Note :
 -

Sheet **3** of **11**
 COMPUTER AIDED DESIGN

This drawing cannot be reproduced, copied or given to third parties without FRIULAIR's written authorization

Questo disegno non può essere copiato, riprodotto né ceduto a terzi senza autorizzazione scritta della FRIULAIR S.r.l.

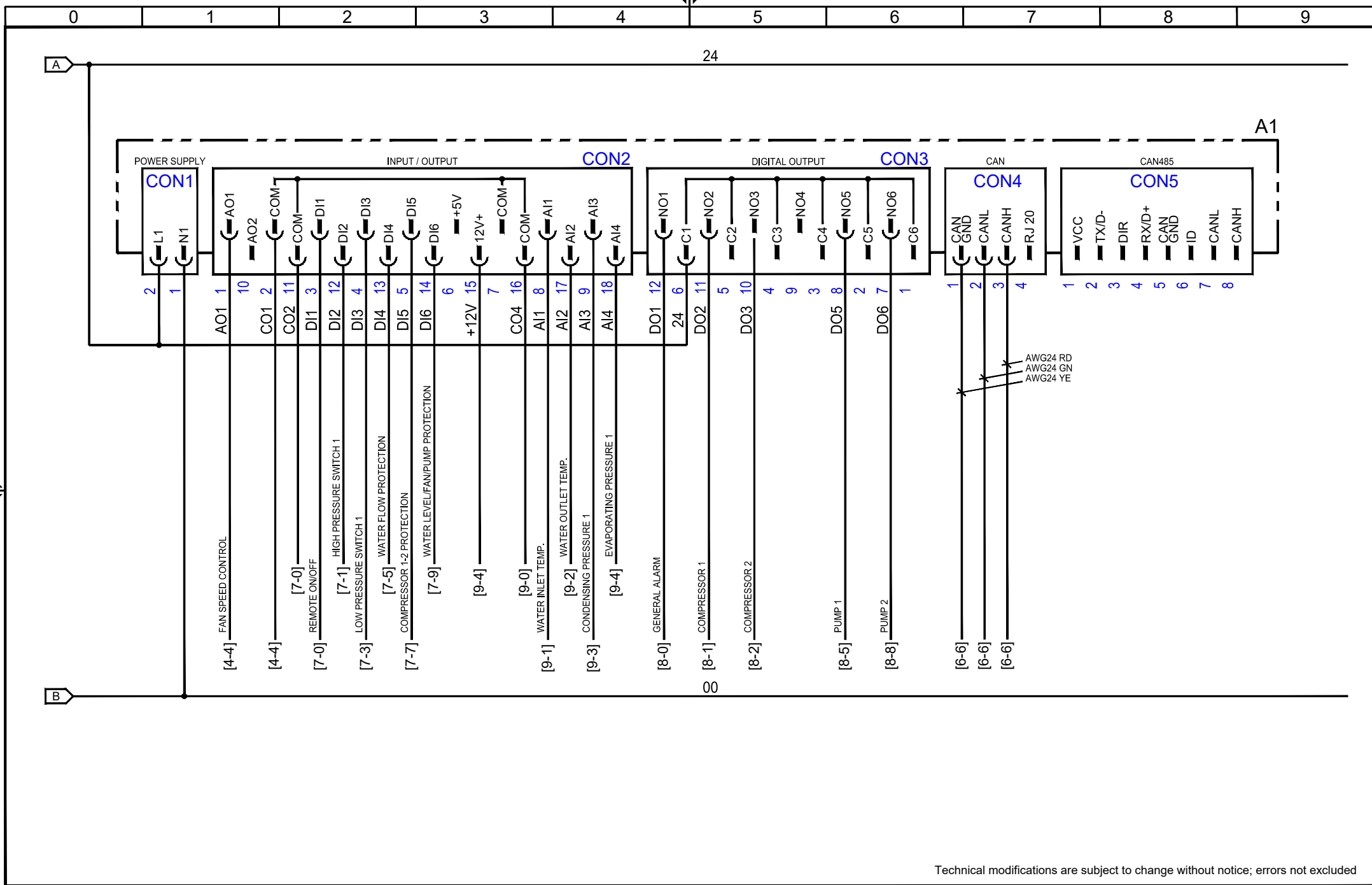

Technical modifications are subject to change without notice; errors not excluded



Titolo / Title : **SCHEMA ELETTRICO CWU130-150**
ELECTRICAL DIAGRAM CWU130-150
 FRIULAIR S.r.l. - 33050 CERVIGNANO DEL FRIULI (UD) - ITALY - Via Cisis, 36

Drawing no. : **FRCWU90CWU130Q000** Rev. **01**
 Note :
 - Sheet **4** of **11**

This drawing cannot be reproduced, copied or given to third parties without FRIULAIR's written authorization

Questo disegno non può essere copiato, riprodotto né ceduto a terzi senza autorizzazione scritta della FRIULAIR S.r.l.

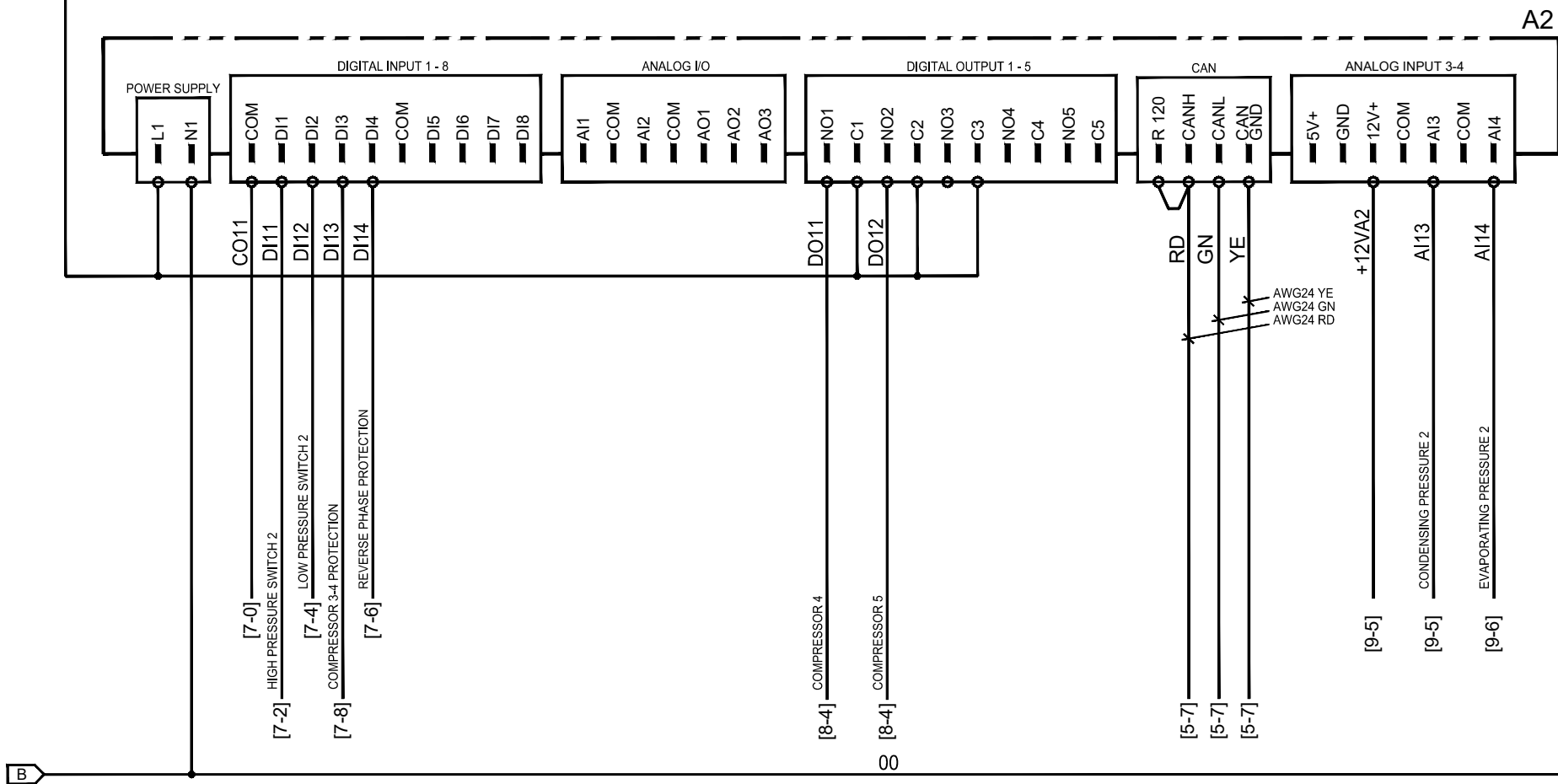

Technical modifications are subject to change without notice; errors not excluded



Titolo / Title : **SCHEMA ELETTRICO CWU130-150**
ELECTRICAL DIAGRAM CWU130-150
 FRIULAIR S.r.l. - 33050 CERVIGNANO DEL FRIULI (UD) - ITALY - Via Cisis, 36

Drawing no. : **FRCWU90CWU130Q0000** Rev. **01**
 Note :
 - Sheet **5** of **11**

This drawing cannot be reproduced, copied or given to third parties without FRIULAIR's written authorization

Questo disegno non può essere copiato, riprodotto né ceduto a terzi senza autorizzazione scritta della FRIULAIR S.r.l.

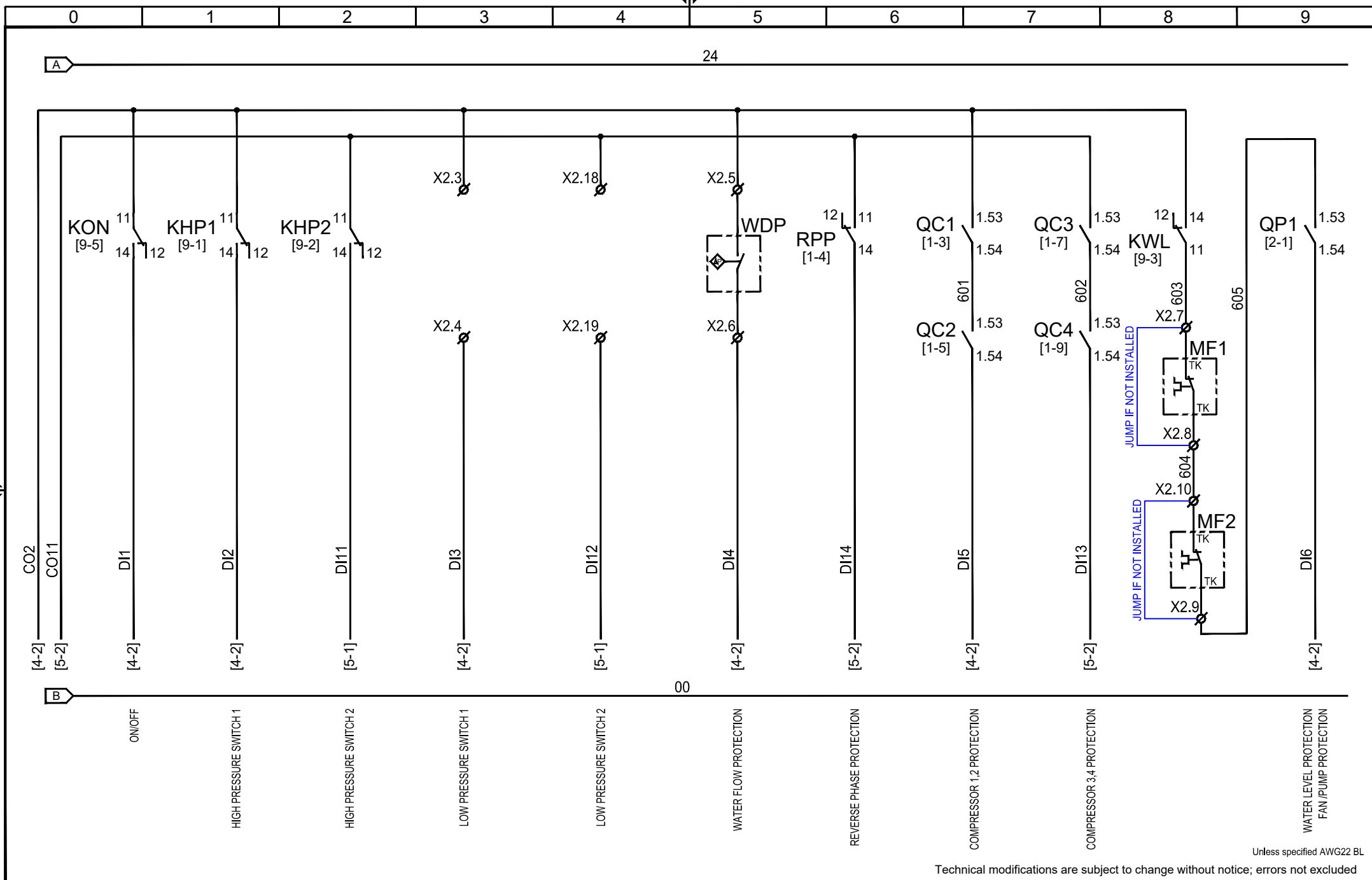

Unless specified AWG22 BL
 Technical modifications are subject to change without notice; errors not excluded



Titolo / Title : **SCHEMA ELETTRICO CWU130-150**
ELECTRICAL DIAGRAM CWU130-150
 FRIULAIR S.r.l. - 33050 CERVIGNANO DEL FRIULI (UD) - ITALY - Via Cisis, 36

Drawing no. : **FRCWU90CWU130Q0000** Rev. **01**
 Note :
 Sheet **6** of **11**
 COMPUTER AIDED DESIGN

This drawing cannot be reproduced, copied or given to third parties without FRIULAIR's written authorization

Questo disegno non può essere copiato, riprodotto né ceduto a terzi senza autorizzazione scritta della FRIULAIR S.r.l.

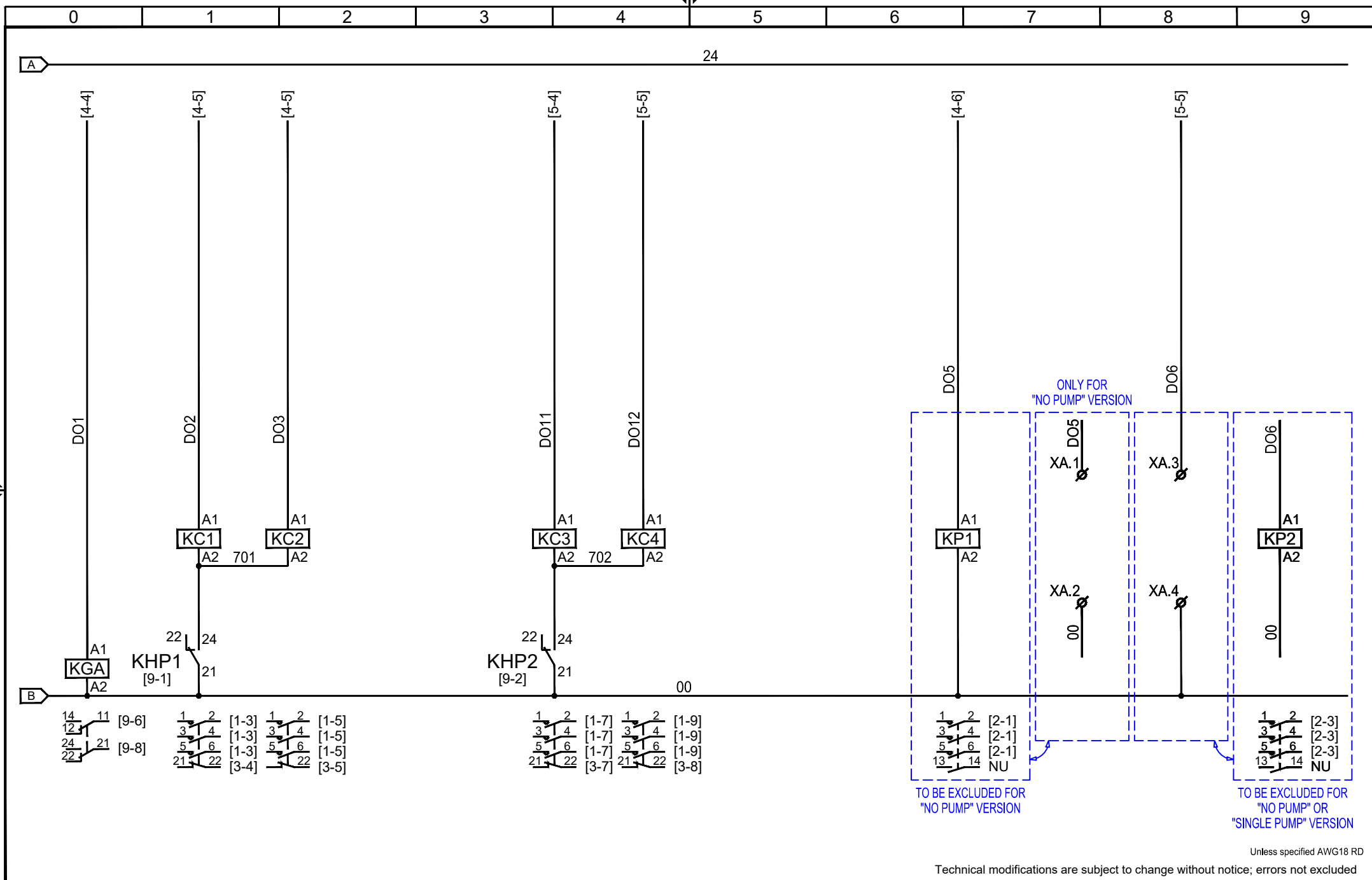

TO BE EXCLUDED FOR "NO PUMP" VERSION

TO BE EXCLUDED FOR "NO PUMP" OR "SINGLE PUMP" VERSION

Unless specified AWG18 RD
 Technical modifications are subject to change without notice; errors not excluded



Titolo / Title : **SCHEMA ELETTRICO CWU130-150**
ELECTRICAL DIAGRAM CWU130-150
 FRIULAIR S.r.l. - 33050 CERVIGNANO DEL FRIULI (UD) - ITALY - Via Cisis, 36

Drawing no. : **FRCWU90CWU130Q0000** Rev. **01**
 Note :
 - Sheet **7** of **11**
 COMPUTER AIDED DESIGN

This drawing cannot be reproduced, copied or given to third parties without FRIULAIR's written authorization

Questo disegno non può essere copiato, riprodotto né ceduto a terzi senza autorizzazione scritta della FRIULAIR S.r.l.

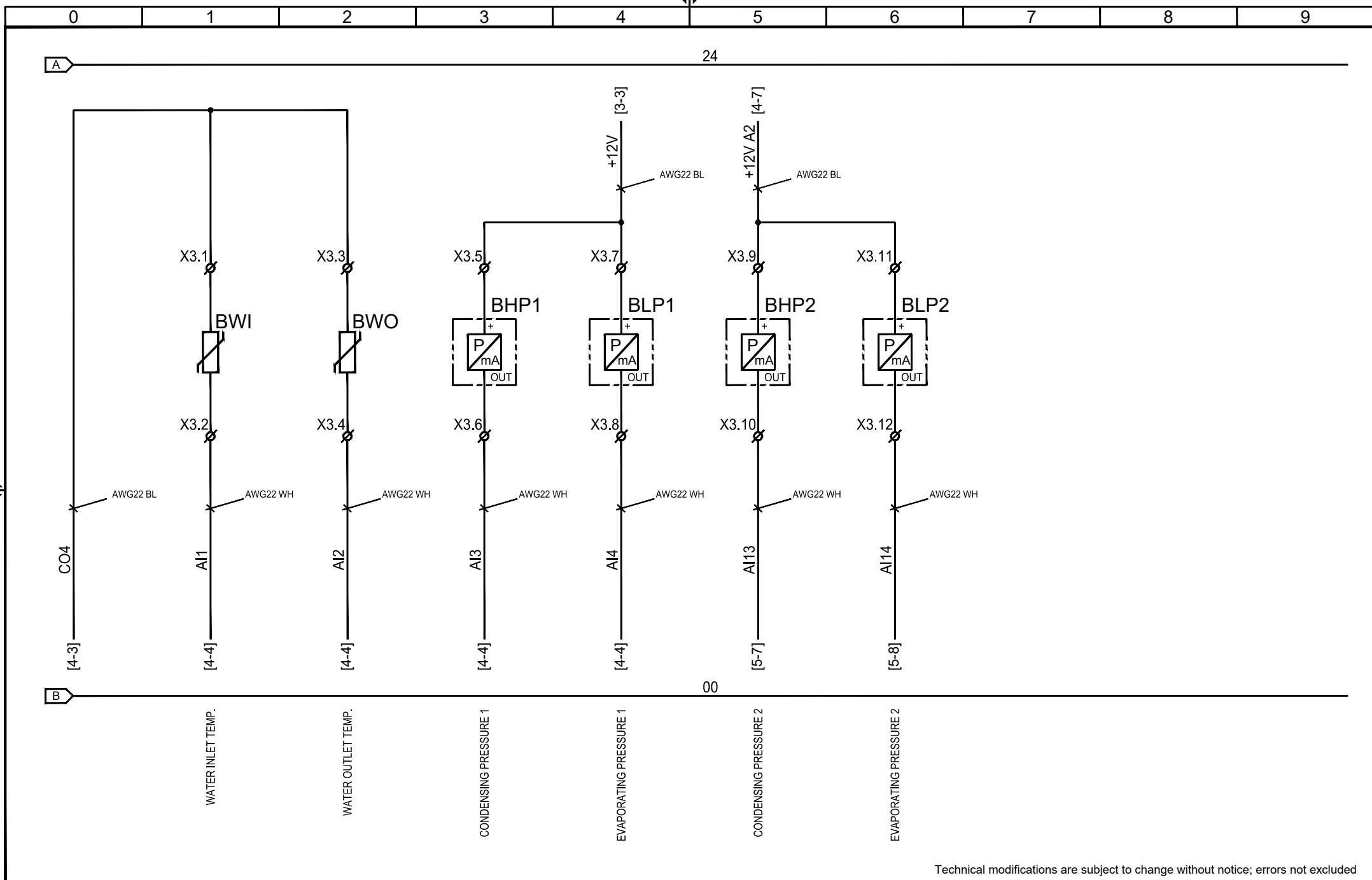

Technical modifications are subject to change without notice; errors not excluded



Titolo / Title :

SCHEMA ELETTRICO CWU130-150
ELECTRICAL DIAGRAM CWU130-150

FRIULAIR S.r.l. - 33050 CERVIGNANO DEL FRIULI (UD) - ITALY - Via Cisis, 36

Drawing no. : FRCWU90CWU130Q000 Rev. 01

Note : - Sheet 8 of 11

This drawing cannot be reproduced, copied or given to third parties without FRIULAIR's written authorization

Questo disegno non può essere copiato, riprodotto né ceduto a terzi senza autorizzazione scritta della FRIULAIR S.r.l.

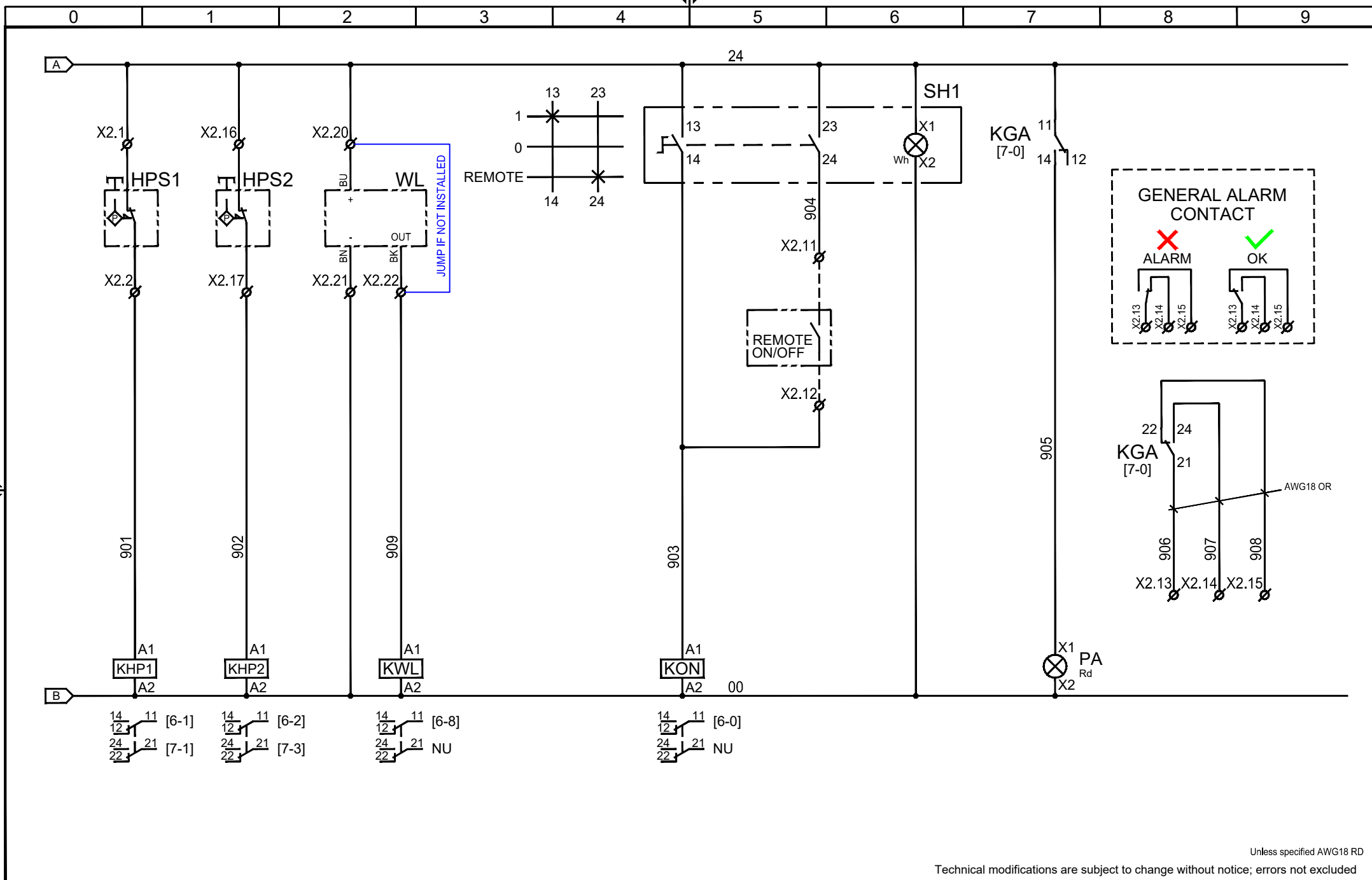

Titolo / Title : **SCHEMA ELETTRICO CWU130-150**
ELECTRICAL DIAGRAM CWU130-150

FRIULAIR S.r.l. - 33050 CERVIGNANO DEL FRIULI (UD) - ITALY - Via Cisis, 36

Drawing no. : **FRCWU90CWU130Q000** Rev. **01**
 Note :
 -

Sheet **9** of **11**

COMPUTER AIDED DESIGN

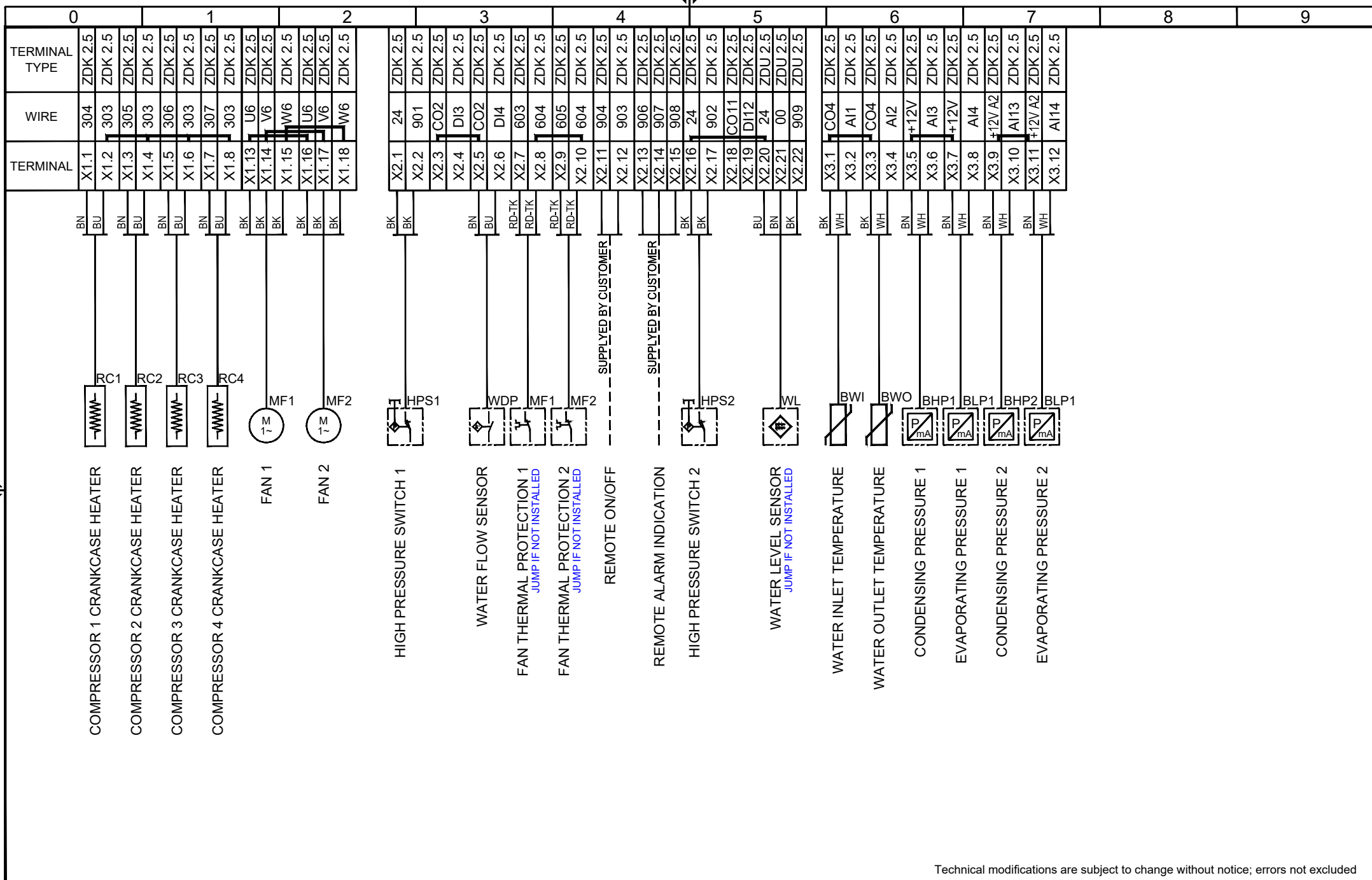

Technical modifications are subject to change without notice; errors not excluded



Titolo / Title : **SCHEMA ELETTRICO CWU130-150**
ELECTRICAL DIAGRAM CWU130-150
 FRIULAIR S.r.l. - 33050 CERVIGNANO DEL FRIULI (UD) - ITALY - Via Cisis, 36

Drawing no. : **FRCWU90CWU130Q000** Rev. **01**
 Note : -
 Sheet **10** of **11**
 COMPUTER AIDED DESIGN

This drawing cannot be reproduced, copied or given to third parties without FRIULAIR's written authorization

Questo disegno non può essere copiato, riprodotto né ceduto a terzi senza autorizzazione scritta della FRIULAIR S.r.l.

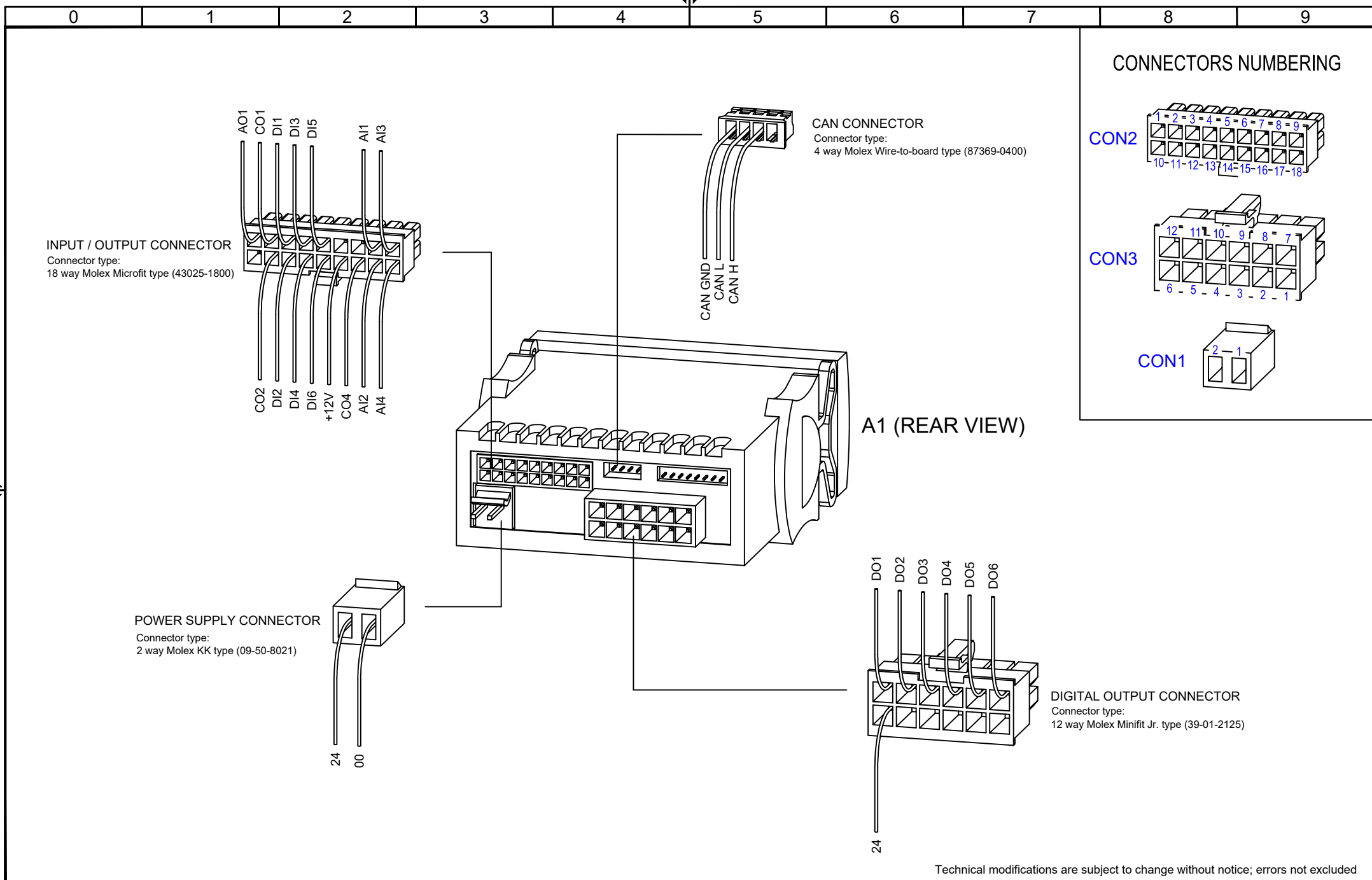

Technical modifications are subject to change without notice; errors not excluded



Titolo / Title : **SCHEMA ELETTRICO CWU130-150**
ELECTRICAL DIAGRAM CWU130-150

FRIULAIR S.r.l. - 33050 CERVIGNANO DEL FRIULI (UD) - ITALY - Via Cisis, 36

Drawing no. : **FRCWU90CWU130Q000** Rev. **01**

Note : -

Sheet **11** of **11**

COMPUTER AIDED DESIGN